

AC 160-5

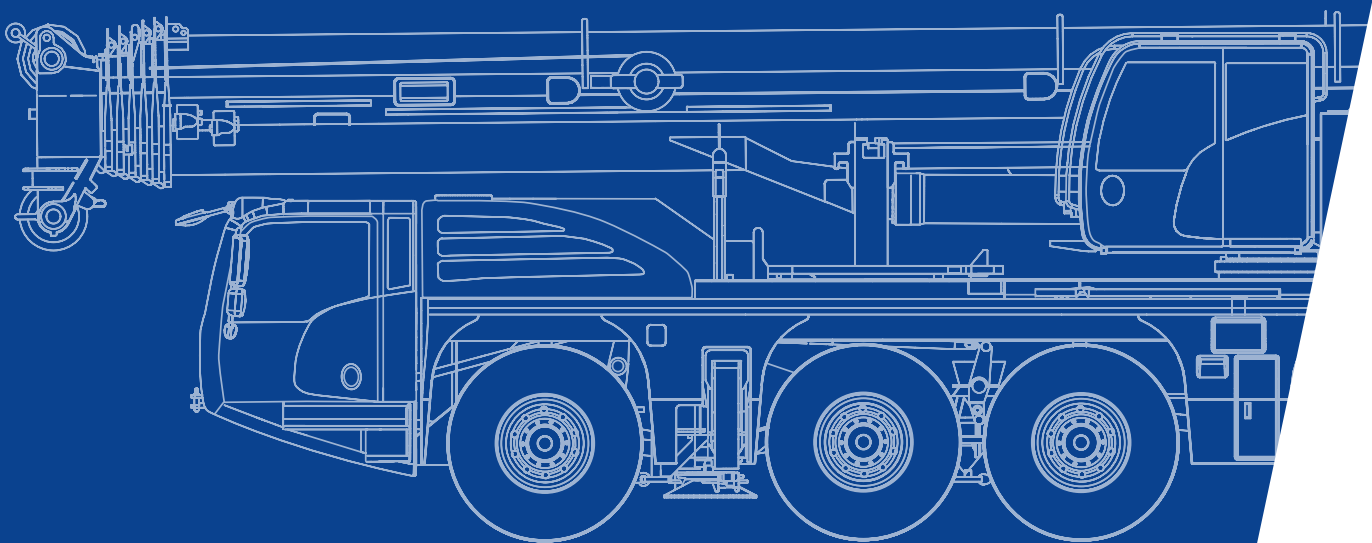

**All Terrain Crane
180 USt Capacity class**

	Page:
Dimensions.....	4
Specifications.....	5
Equipment.....	6
Counterweight.....	7

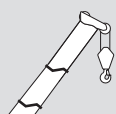

HA

Main boom.....	8
----------------	---



HAV

Folding swing-away jib.....	20
-----------------------------	----

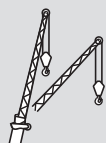

HAV-VA

Variable extension with swing-away jib.....	24
---	----

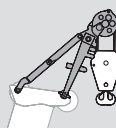

MS

Runner.....	28
-------------	----

Technical description.....	34
----------------------------	----

	Counterweight		Boom telescoping
	Lifting capacities on outriggers - 360°		Boom elevation
	Radius		Working speeds
	Main boom		Max. line pull
	Folding swing-away jib		Rope diameter
	Runner		Rope length
	Max. axle loads		Hook block (capacity-sheaves-rope diameter)
	Mechanism		Number of lines
	Tires		Possible load of hook block
	Hook block		Weight of hook block
	Hoist		Distance head sheave axle – hook ground
	Dolly		Number of sheaves in boom head
	Travel speed		Supporting force
	Gradeability – road		Length of stroke (support cylinders)
	Gradeability – off road		Payload incl. rear storage box
	Slewing		

Dimensions

AC 160-5

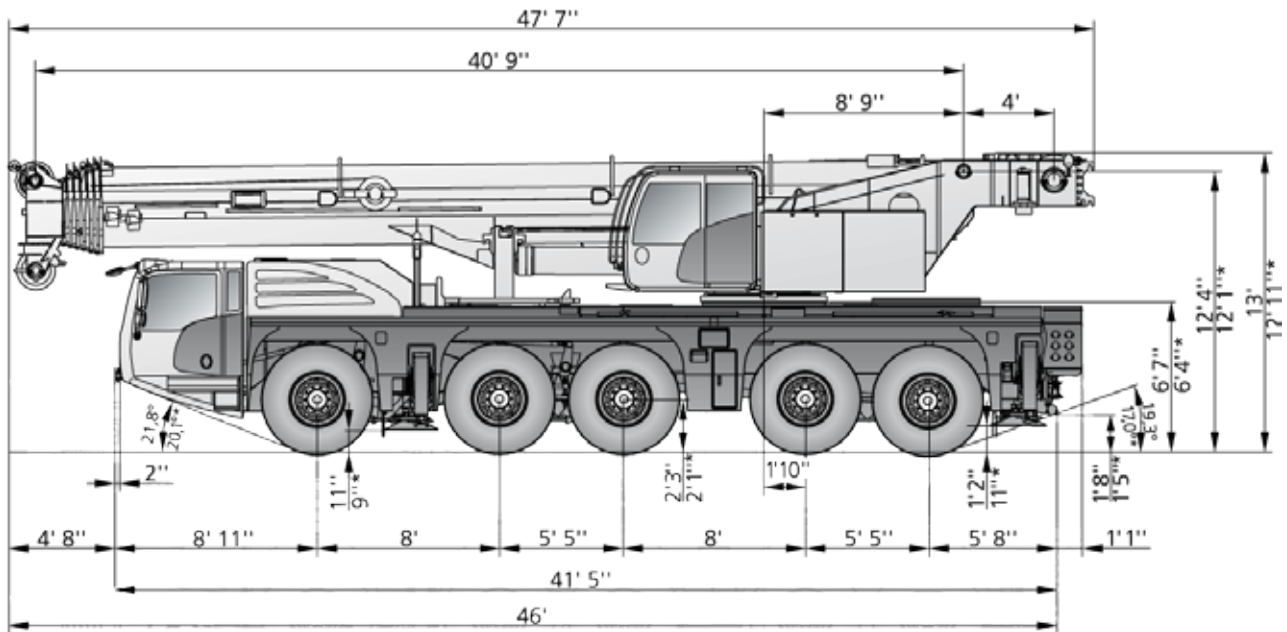

⊗ 445/95 R25 / 525/80 R25

* ⊗ 385/95 R25

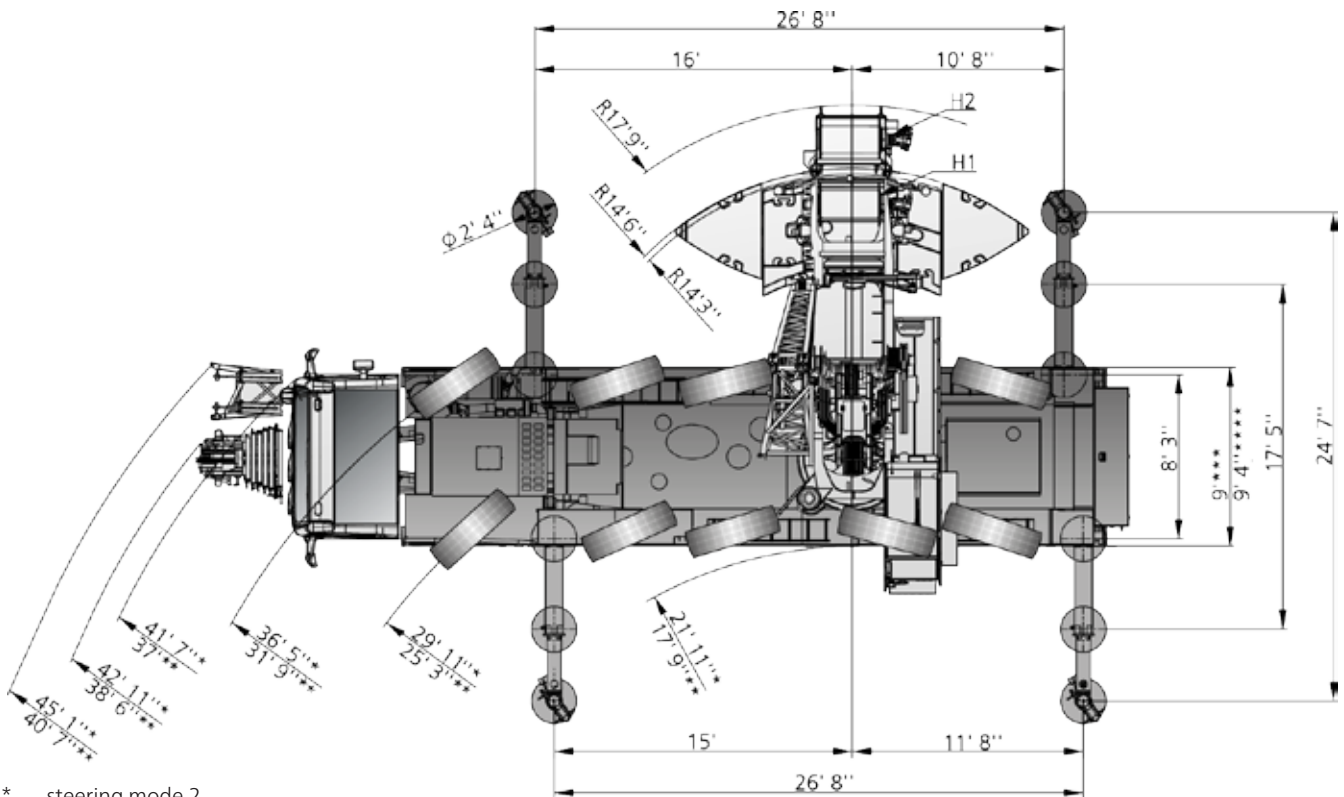

* steering mode 2

** steering mode 3











*** ⊗ 385/95 R25 / 445/95 R25

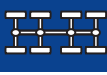





**** ⊗ 525/80 R25

see page 5



Specifications

AC 160-5



									
	Total								
< 20,000 lb				On request!					X
18,100 lb	83,800 lb	10 x 6 x 10	385/95R25	–	–	8,200 lb	–	–	–
26,500 lb	132,300 lb	10 x 8 x 10	445/95R25	223.1 ft	32-1-21	13,900 lb	–	770 lb	–
26,500 lb	132,300 lb	10 x 8 x 10	445/95R25	223.1 ft	80-3-21	8,200 lb	68.9 ft	1430 lb	–
36,400 lb	180,800 lb	10 x 8 x 10	445/95R25	223.1 ft	80-3-21	56,000 lb	68.9 ft	1985 lb	–

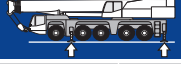







	1 Highway > 28 mph		4* Off-wall
	2 City < 28 mph		5* Crab steer mode
	3 Minimum turning radius		6* All wheel steering







*must be activated

	163,200 lb	183,000 lb	
	19.7 in	23 in	

¹⁾ Depending on tire type, size and country specific legislation

	385 / 95 R 25 14.00 R 25	445 / 95 R 25 16.00 R 25	525 / 80 R 25 20.50 R 25
	47 %	40 %	40 %
	64 %	53 %	53 %

				
1	394 ft/min	22,076 lbf	0.83 in	1083 ft
2	394 ft/min	22,076 lbf	0.83 in	1083 ft
	1,60 min ⁻¹			
	ca. 516 s (40.7-223.1 ft)			
	ca. 33 s (-1,5°-82°)			

					
1	21,800	12-0-21	4	770 lb	6.6 ft
2	43,400	32-1-21	4	1320 lb	8.9 ft
3	64,800	32-1-21	4	1320 lb	8.9 ft
4	86,200	80-3-21	4	1870 lb	9.8 ft
5	107,200	80-3-21	4	1870 lb	9.8 ft
6	127,900	80-3-21	4	1870 lb	9.8 ft
7	148,400	80-3-21	4	1870 lb	9.8 ft
8	168,900	125-5-21	4	2480 lb	9.8 ft
9	189,000	125-5-21	4 + 2	2480 lb	9.8 ft
10	209,000	125-5-21	4 + 2	2480 lb	9.8 ft
11	228,700	160-7-21	4 + 2	3310 lb	9.8 ft
12	248,300	160-7-21	4 + 2	3310 lb	9.8 ft

HAV / HAV-VA

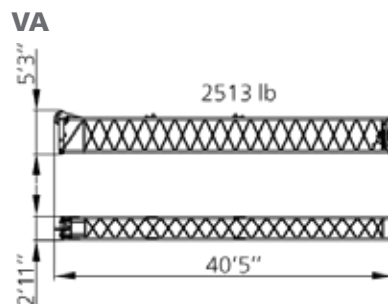
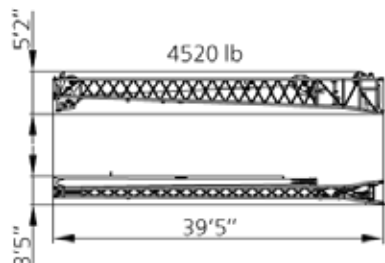

HAV-VA 108.3 ft

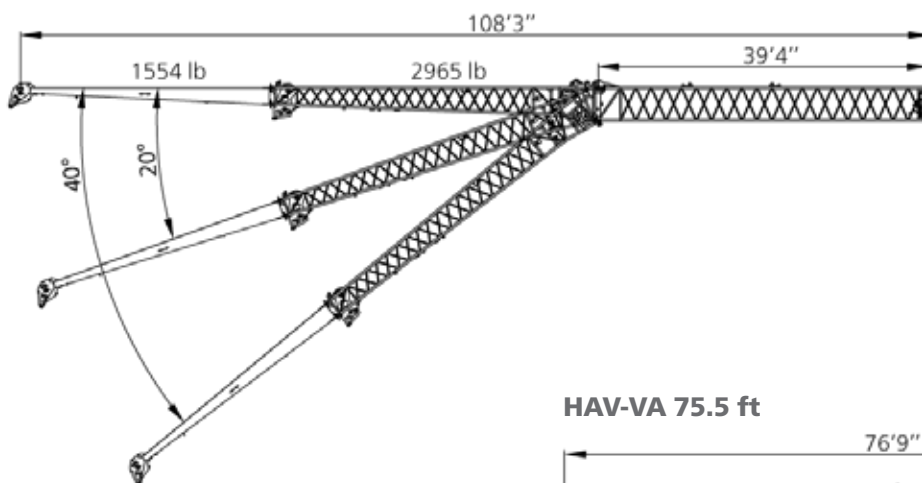

HAV-VA 75.5 ft

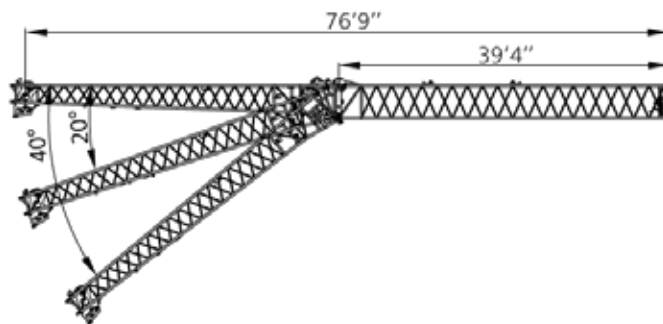

HAV 68.9 ft

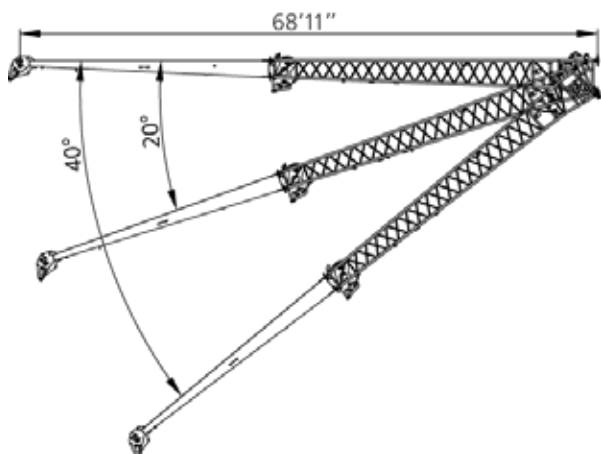

HAV 36.1 ft

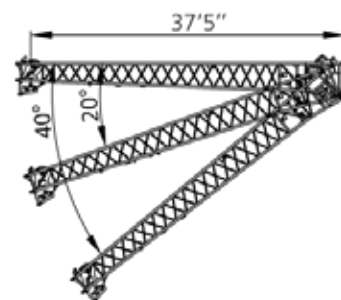

Counterweight

AC 160-5

Parts

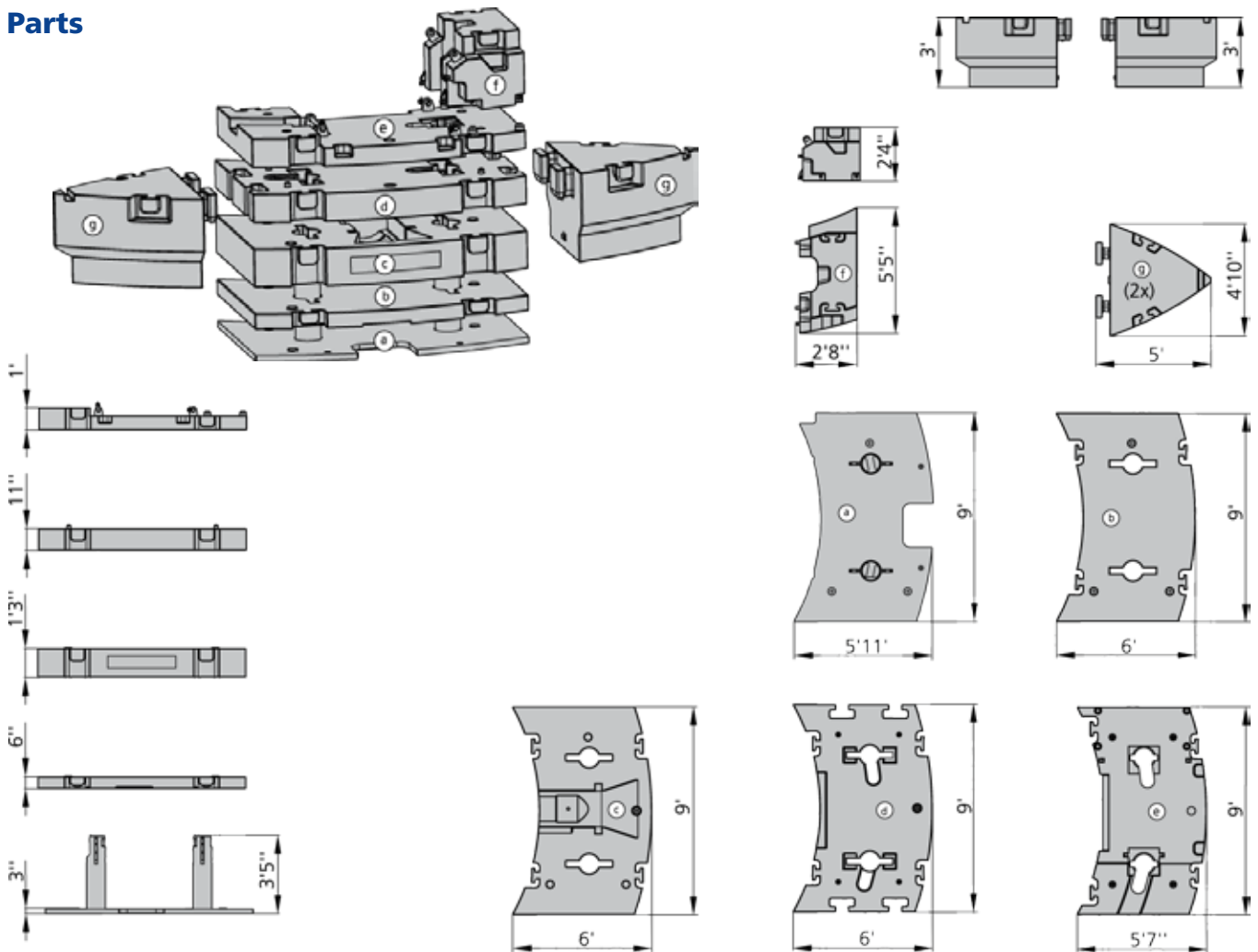

Configurations

	(a) 5,700 lb	(b) 9,500 lb	(c) 21,400 lb	(d) 15,900 lb	(e) 11,250 lb	(f) 8,200 lb	(g) 14,800 lb	(h) 14,800 lb
0 lb								
5,700 lb	X							
8,200 lb						X		
13,900 lb	X					X		
15,200 lb	X	X						
19,400 lb					X	X		
23,400 lb	X	X				X		
25,100 lb	X				X	X		
34,600 lb	X	X			X	X		
36,600 lb	X	X	X					
44,800 lb	X	X	X			X		
52,500 lb	X	X	X	X				
56,000 lb	X	X	X		X	X		
60,600 lb	X	X	X	X		X		
63,700 lb	X	X	X	X	X			
71,900 lb	X	X	X	X	X	X		
82,000 lb	X	X	X	X			X	X
90,200 lb	X	X	X	X		X	X	X
93,300 lb	X	X	X	X	X		X	X
101,400 lb	X	X	X	X	X	X	X	X

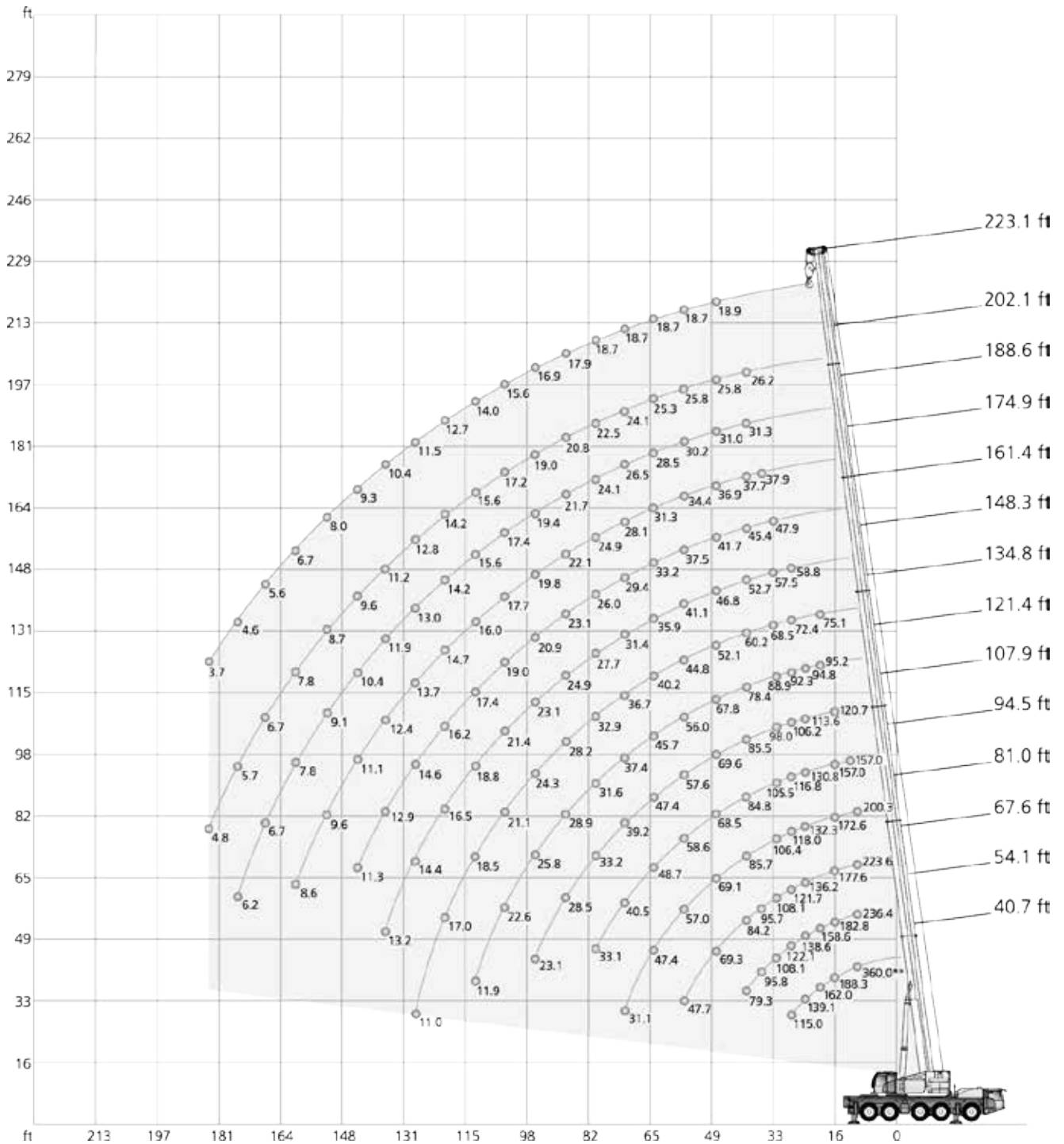
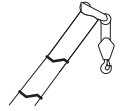

** Capacity class

☰ 101,400 lb		📏 26.70 ft x 24.60 ft														360°		85%	
📏		(ft)														📏			
ft		40.7*	40.7	54.1	67.6	81.0	94.5	107.9	121.4	134.8	148.3	161.4	174.9	188.6	202.1	223.1	ft		
1,000 lb																			
8	360.0**	-	-	-	-	-	-	-	-	-	-	-	-	-	-	-	-	8	
10	243.0	243.0	236.4	223.6	200.3	-	-	-	-	-	-	-	-	-	-	-	-	10	
12	222.1	222.0	215.4	207.8	196.5	157.0	-	-	-	-	-	-	-	-	-	-	-	12	
14	204.1	202.7	197.8	192.5	184.0	157.0	-	-	-	-	-	-	-	-	-	-	-	14	
16	188.3	185.4	182.8	177.6	172.6	157.0	120.7	-	-	-	-	-	-	-	-	-	-	16	
18	174.8	171.3	170.4	165.5	161.2	151.9	120.4	-	-	-	-	-	-	-	-	-	-	18	
20	162.0	158.1	158.6	154.2	150.0	145.5	119.9	95.2	-	-	-	-	-	-	-	-	-	20	
24	139.1	137.0	138.6	136.2	132.3	130.8	113.6	94.8	75.1	-	-	-	-	-	-	-	-	24	
28	115.0	115.0	122.1	121.7	118.0	116.8	106.2	92.3	72.4	58.8	-	-	-	-	-	-	-	28	
32	-	-	108.1	108.1	106.4	105.5	98.0	88.9	68.5	57.5	47.9	-	-	-	-	-	-	32	
36	-	-	95.8	95.7	95.0	95.0	92.0	83.8	64.4	55.3	46.7	37.9	-	-	-	-	-	36	
40	-	-	79.3	84.2	85.7	84.8	85.5	78.4	60.2	52.7	45.4	37.7	31.3	26.2	-	-	-	40	
48	-	-	-	69.3	69.1	68.5	69.6	67.8	52.1	46.8	41.7	36.9	31.0	25.8	18.9	-	-	48	
56	-	-	-	47.7	57.0	58.6	57.6	56.0	44.8	41.1	37.5	34.4	30.2	25.8	18.7	-	-	56	
64	-	-	-	-	47.4	48.7	47.4	45.7	40.2	35.9	33.2	31.3	28.5	25.3	18.7	-	-	64	
72	-	-	-	-	31.1	40.5	39.2	37.4	36.7	31.4	29.4	28.1	26.5	24.1	18.7	-	-	72	
80	-	-	-	-	-	33.1	33.2	31.6	32.9	27.7	26.0	24.9	24.1	22.5	18.7	-	-	80	
88	-	-	-	-	-	-	28.5	28.9	28.2	24.9	23.1	22.1	21.7	20.8	17.9	-	-	88	
96	-	-	-	-	-	-	23.1	25.8	24.3	23.1	20.9	19.8	19.4	19.0	16.9	-	-	96	
104	-	-	-	-	-	-	-	22.6	21.1	21.4	19.0	17.7	17.4	17.2	15.6	-	-	104	
112	-	-	-	-	-	-	-	11.9	18.5	18.8	17.4	16.0	15.6	15.6	14.0	-	-	112	
120	-	-	-	-	-	-	-	-	17.0	16.5	16.2	14.7	14.2	14.2	12.7	-	-	120	
128	-	-	-	-	-	-	-	-	11.0	14.4	14.6	13.7	13.0	12.8	11.5	-	-	128	
136	-	-	-	-	-	-	-	-	-	13.2	12.9	12.4	11.9	11.2	10.4	-	-	136	
144	-	-	-	-	-	-	-	-	-	-	11.3	11.1	10.4	9.6	9.3	-	-	144	
152	-	-	-	-	-	-	-	-	-	-	-	9.6	9.1	8.7	8.0	-	-	152	
160	-	-	-	-	-	-	-	-	-	-	-	8.6	7.8	7.8	6.7	-	-	160	
168	-	-	-	-	-	-	-	-	-	-	-	-	6.7	6.7	5.6	-	-	168	
176	-	-	-	-	-	-	-	-	-	-	-	-	6.2	5.7	4.6	-	-	176	
184	-	-	-	-	-	-	-	-	-	-	-	-	-	4.8	3.7	-	-	184	
1)	45.0	45.0	32.8	25.6	20.3	16.5	13.2	10.6	7.9	6.0	4.9	2.9	-	-	-	-	-	1)	

1) Capacities with horizontal boom

* over rear

** Capacity class

71,900 lb		26.70 ft x 24.60 ft										360° / Max.*				85%
		360°	Max.	360°	Max.	360°	Max.	360°	Max.	360°	Max.	360°	Max.	360°	Max.	
ft		40.7ft	40.7ft	54.1ft	54.1ft	67.6ft	67.6ft	81.0ft	81.0ft	94.5ft	94.5ft	107.9ft	107.9ft	121.4ft	121.4ft	ft
1,000 lb																
10	242.9	243.0	236.4	236.4	223.6	223.6	200.3	200.3	-	-	-	-	-	-	-	10
12	220.6	222.0	215.4	215.4	207.8	207.8	196.5	196.5	157.0	157.0	-	-	-	-	-	12
14	200.9	202.7	197.8	197.8	192.5	192.5	184.0	184.0	157.0	157.0	-	-	-	-	-	14
16	183.6	185.4	182.8	182.8	177.6	177.7	172.6	172.6	157.0	157.0	120.7	120.7	-	-	-	16
18	169.5	171.3	169.9	170.4	165.5	165.5	161.2	161.2	151.9	151.9	120.4	120.4	-	-	-	18
20	156.4	158.1	157.7	158.6	154.2	154.2	150.0	150.0	145.5	145.5	119.9	119.9	95.2	95.2	20	
24	134.9	136.3	136.4	137.9	135.4	135.8	132.3	132.3	130.8	130.8	113.6	113.6	94.8	94.8	24	
28	113.3	114.1	116.8	117.5	117.0	117.4	116.3	116.3	116.1	116.1	106.2	106.2	92.3	92.3	28	
32	-	-	101.1	101.1	100.4	100.4	101.9	101.9	100.9	100.9	98.0	98.0	88.9	88.9	32	
36	-	-	88.8	88.9	87.6	87.8	89.3	89.3	88.1	88.3	88.7	88.7	82.1	83.6	36	
40	-	-	69.6	72.3	78.1	78.5	77.6	78.1	78.8	79.2	78.5	78.7	74.1	77.4	40	
48	-	-	-	-	57.9	63.2	59.8	62.8	59.6	64.3	58.3	63.4	56.2	62.1	48	
56	-	-	-	-	37.5	45.1	47.1	53.4	46.4	53.4	45.2	52.3	43.3	50.8	56	
64	-	-	-	-	-	-	38.0	44.8	37.3	44.2	36.2	43.1	36.9	41.5	64	
72	-	-	-	-	-	-	28.7	30.1	30.8	36.8	31.6	35.7	31.0	34.2	72	
80	-	-	-	-	-	-	-	-	26.4	30.4	27.1	30.1	26.0	31.1	80	
88	-	-	-	-	-	-	-	-	-	-	23.3	26.8	22.1	27.1	88	
96	-	-	-	-	-	-	-	-	-	-	20.1	23.1	19.2	23.5	96	
104	-	-	-	-	-	-	-	-	-	-	-	-	17.8	20.6	104	
112	-	-	-	-	-	-	-	-	-	-	-	-	11.9	11.9	112	
1)	45.0	45.0	32.8	32.8	25.6	25.6	20.3	20.3	16.5	16.5	13.2	13.2	10.6	10.6	1)	

		360°	Max.	360°	Max.	360°	Max.	360°	Max.	360°	Max.	360°	Max.	360°	Max.	
ft		134.8ft	134.8ft	148.3ft	148.3ft	161.4ft	161.4ft	174.9ft	174.9ft	188.6ft	188.6ft	202.1ft	202.1ft	223.1ft	223.1ft	ft
1,000 lb																
24	75.1	75.1	-	-	-	-	-	-	-	-	-	-	-	-	-	24
28	72.4	72.4	58.8	58.8	-	-	-	-	-	-	-	-	-	-	-	28
32	68.5	68.6	57.5	57.5	47.9	47.9	-	-	-	-	-	-	-	-	-	32
36	64.4	64.4	55.3	55.3	46.7	46.7	37.9	37.9	-	-	-	-	-	-	-	36
40	60.2	60.2	52.7	52.7	45.4	45.4	37.7	37.7	31.3	31.3	26.2	26.2	-	-	-	40
48	51.7	52.1	46.8	46.8	41.7	41.7	36.9	36.9	31.0	31.0	25.8	25.8	18.9	18.9	48	
56	43.6	44.8	40.4	41.1	37.5	37.5	34.4	34.4	30.2	30.2	25.8	25.8	18.7	18.7	56	
64	36.0	40.2	33.6	35.9	32.4	33.2	31.3	31.3	28.5	28.5	25.3	25.3	18.7	18.7	64	
72	29.2	35.4	29.4	31.4	27.9	29.4	27.0	28.1	26.5	26.5	24.1	24.1	18.7	18.7	72	
80	25.0	29.9	25.1	27.5	23.5	26.0	23.6	24.9	22.9	24.1	22.4	22.5	18.7	18.7	80	
88	22.5	25.6	21.1	24.9	21.3	23.0	20.7	22.1	20.3	21.7	19.7	20.8	17.9	17.9	88	
96	19.6	22.1	18.8	22.5	18.2	20.6	18.0	19.7	17.3	19.4	16.6	19.0	15.9	16.9	96	
104	16.9	19.6	16.8	19.7	15.9	18.5	15.7	17.6	14.4	17.4	14.6	17.2	13.3	15.6	104	
112	14.7	18.4	14.4	17.1	14.2	17.3	13.3	16.0	12.7	15.6	12.2	15.5	11.1	14.0	112	
120	13.5	16.5	12.6	15.0	12.2	15.2	11.9	14.7	11.5	14.2	10.2	13.7	9.1	12.7	120	
128	11.0	11.0	11.3	14.0	10.6	13.3	10.6	13.1	9.7	12.6	8.6	11.8	7.5	11.5	128	
136	-	-	10.0	13.0	9.1	11.8	9.1	11.4	8.2	10.9	7.1	10.4	6.0	10.1	136	
144	-	-	-	-	8.4	10.8	7.8	10.0	6.9	9.5	5.8	9.5	4.7	8.4	144	
152	-	-	-	-	-	-	6.7	9.2	5.8	8.2	4.7	8.2	3.6	7.3	152	
160	-	-	-	-	-	-	5.7	8.3	4.8	7.2	3.6	7.2	-	6.1	160	
168	-	-	-	-	-	-	-	-	4.0	6.6	-	6.1	-	5.0	168	
176	-	-	-	-	-	-	-	-	3.2	6.2	-	5.2	-	4.1	176	
184	-	-	-	-	-	-	-	-	-	-	-	4.4	-	3.4	184	
1)	7.9	7.9	6.0	6.0	4.9	4.9	2.9	2.9	-	-	-	-	-	-	1)	

1) Capacities with horizontal boom
 * Max. values are valid only for specific superstructure positions

56,000 lb		26.70 ft x 24.60 ft										360° / Max.*				85%
ft	360° 40.7ft	Max. 40.7ft	360° 54.1ft	Max. 54.1ft	360° 67.6ft	Max. 67.6ft	360° 81.0ft	Max. 81.0ft	360° 94.5ft	Max. 94.5ft	360° 107.9ft	Max. 107.9ft	360° 121.4ft	Max. 121.4ft	ft	
1,000 lb																
10	242.8	243.0	236.4	236.4	223.6	223.6	200.3	200.3	-	-	-	-	-	-	10	
12	219.5	222.0	215.4	215.4	207.8	207.8	196.5	196.5	157.0	157.0	-	-	-	-	12	
14	199.8	202.7	197.8	197.8	192.5	192.5	184.0	184.0	157.0	157.0	-	-	-	-	14	
16	182.7	185.4	182.8	182.8	177.6	177.7	172.6	172.6	157.0	157.0	120.7	120.7	-	-	16	
18	168.7	171.3	169.5	170.4	165.5	165.5	161.2	161.2	151.9	151.9	120.4	120.4	-	-	18	
20	155.4	157.8	156.5	158.4	154.0	154.2	150.0	150.0	145.5	145.5	119.9	119.9	95.2	95.2	20	
24	130.3	132.3	132.2	134.0	132.5	133.9	130.8	130.9	130.3	130.3	113.6	113.6	94.8	94.8	24	
28	110.1	110.4	111.7	111.9	111.8	111.9	113.4	113.4	112.0	112.4	102.9	106.2	92.3	92.3	28	
32	-	-	96.6	96.6	96.3	96.3	97.0	97.0	93.9	95.9	91.8	96.0	84.4	88.9	32	
36	-	-	80.9	84.7	81.8	85.2	81.4	85.0	81.8	85.0	79.4	85.7	73.5	81.6	36	
40	-	-	58.5	68.9	67.0	74.6	69.9	74.4	69.0	75.9	67.7	75.0	63.1	73.5	40	
48	-	-	-	-	51.5	60.1	51.7	60.9	51.1	61.2	49.7	60.2	47.8	58.9	48	
56	-	-	-	-	30.5	43.7	40.2	51.1	39.5	50.7	38.7	49.7	39.6	48.4	56	
64	-	-	-	-	-	-	32.3	43.3	31.6	42.7	32.9	41.8	31.8	40.5	64	
72	-	-	-	-	-	-	26.6	29.7	27.6	36.7	27.0	35.6	25.9	34.2	72	
80	-	-	-	-	-	-	-	-	23.5	30.4	22.8	30.1	22.9	31.1	80	
88	-	-	-	-	-	-	-	-	-	-	19.3	26.8	19.9	27.1	88	
96	-	-	-	-	-	-	-	-	-	-	17.4	23.1	16.9	23.5	96	
104	-	-	-	-	-	-	-	-	-	-	-	-	14.6	20.6	104	
112	-	-	-	-	-	-	-	-	-	-	-	-	11.9	11.9	112	
1)	45.0	45.0	32.8	32.8	25.6	25.6	20.3	20.3	16.5	16.5	13.2	13.2	10.6	10.6	1)	

ft	360° 134.8ft	Max. 134.8ft	360° 148.3ft	Max. 148.3ft	360° 161.4ft	Max. 161.4ft	360° 174.9ft	Max. 174.9ft	360° 188.6ft	Max. 188.6ft	360° 202.1ft	Max. 202.1ft	360° 223.1ft	Max. 223.1ft	ft
1,000 lb															
24	75.1	75.1	-	-	-	-	-	-	-	-	-	-	-	-	24
28	72.4	72.4	58.8	58.8	-	-	-	-	-	-	-	-	-	-	28
32	68.5	68.6	57.5	57.5	47.9	47.9	-	-	-	-	-	-	-	-	32
36	64.4	64.4	55.3	55.3	46.7	46.7	37.9	37.9	-	-	-	-	-	-	36
40	59.7	60.2	52.5	52.7	45.4	45.4	37.7	37.7	31.3	31.3	26.2	26.2	-	-	40
48	48.0	52.1	44.3	46.8	41.0	41.7	36.9	36.9	31.0	31.0	25.8	25.8	18.9	18.9	48
56	38.0	44.8	35.8	41.1	35.2	37.5	33.1	34.4	30.2	30.2	25.8	25.8	18.7	18.7	56
64	30.3	40.2	30.6	35.9	28.8	33.2	28.6	31.3	26.9	28.5	25.3	25.3	18.7	18.7	64
72	26.5	35.0	25.2	31.4	25.2	29.4	25.0	28.1	24.3	26.5	22.8	24.1	18.7	18.7	72
80	22.2	29.9	22.2	27.3	21.0	25.9	21.3	24.9	20.1	24.1	19.7	22.5	17.7	18.7	80
88	18.9	25.6	18.8	24.9	18.5	23.0	17.8	22.1	17.5	21.7	16.2	20.8	14.4	17.9	88
96	16.7	22.1	16.1	22.5	15.6	20.6	15.4	19.4	14.8	19.4	13.5	19.0	11.8	16.9	96
104	14.4	19.6	13.9	19.7	13.1	18.5	13.3	17.6	12.2	17.0	11.1	17.2	9.5	15.6	104
112	12.7	18.4	11.8	17.1	11.8	17.3	11.1	16.0	10.3	15.6	8.9	15.1	7.6	14.0	112
120	10.9	16.5	10.0	15.0	10.3	15.2	9.4	14.7	8.4	14.2	7.3	13.4	6.1	12.3	120
128	9.4	11.0	8.7	14.0	8.8	13.3	7.9	13.1	6.9	12.6	5.8	11.7	4.7	10.6	128
136	-	-	7.4	13.0	7.5	11.6	6.6	11.4	5.6	10.9	4.5	10.4	3.4	9.1	136
144	-	-	-	-	6.4	10.8	5.4	10.0	4.5	9.5	3.4	9.5	-	7.8	144
152	-	-	-	-	-	-	4.5	9.2	3.4	8.2	-	8.2	-	6.5	152
160	-	-	-	-	-	-	3.6	8.3	-	7.2	-	6.7	-	5.6	160
168	-	-	-	-	-	-	-	-	-	6.5	-	5.7	-	4.6	168
176	-	-	-	-	-	-	-	-	-	5.8	-	4.8	-	3.7	176
184	-	-	-	-	-	-	-	-	-	-	-	3.9	-	2.8	184
1)	7.9	7.9	6.0	6.0	4.9	4.9	2.9	2.9	-	-	-	-	-	-	1)

1) Capacities with horizontal boom

* Max. values are valid only for specific superstructure positions

13,900 lb		26.70 ft x 24.60 ft		360° / Max.*										85%	
ft	360°	Max.	360°	Max.	360°	Max.	360°	Max.	360°	Max.	360°	Max.	360°	Max.	ft
	40.7ft	40.7ft	54.1ft	54.1ft	67.6ft	67.6ft	81.0ft	81.0ft	94.5ft	94.5ft	107.9ft	107.9ft	121.4ft	121.4ft	
1,000 lb															
10	240.5	243.0	236.4	236.4	223.6	223.6	200.3	200.3	-	-	-	-	-	-	10
12	216.3	222.0	215.4	215.4	207.8	207.8	196.5	196.5	157.0	157.0	-	-	-	-	12
14	197.0	202.7	197.6	197.8	192.5	192.5	184.0	184.0	157.0	157.0	-	-	-	-	14
16	176.6	182.9	178.2	182.8	177.1	177.7	164.8	172.6	150.5	157.0	120.7	120.7	-	-	16
18	157.8	162.1	159.3	163.5	153.0	160.9	143.3	158.1	130.5	151.9	113.8	120.4	-	-	18
20	139.3	142.1	140.4	143.8	132.0	143.8	120.7	144.4	115.2	144.3	104.9	119.9	93.5	95.2	20
24	99.0	114.6	102.7	117.6	97.9	116.9	95.1	118.0	88.3	116.2	81.0	110.4	74.8	94.8	24
28	69.4	95.3	74.9	98.0	78.0	98.6	75.3	97.8	70.5	98.5	64.8	96.1	63.1	85.3	28
32	-	-	57.9	83.4	60.3	84.0	60.4	84.4	57.5	83.8	56.5	77.8	52.8	68.7	32
36	-	-	46.7	71.8	48.9	72.3	49.4	73.9	48.4	71.1	48.6	64.9	44.8	58.5	36
40	-	-	28.4	54.9	40.7	64.2	41.0	64.0	41.8	59.9	40.9	54.5	40.0	52.6	40
48	-	-	-	-	29.6	49.5	30.5	49.1	30.2	45.9	30.9	43.3	30.3	41.4	48
56	-	-	-	-	22.3	30.1	23.1	36.5	23.5	35.4	24.0	36.4	23.5	33.0	56
64	-	-	-	-	-	-	17.9	27.8	18.6	29.2	18.6	28.7	18.6	27.9	64
72	-	-	-	-	-	-	14.2	23.7	14.8	23.3	14.8	23.2	14.6	23.3	72
80	-	-	-	-	-	-	-	-	11.7	19.4	11.7	19.8	11.5	19.3	80
88	-	-	-	-	-	-	-	-	-	-	9.4	17.1	9.2	16.7	88
96	-	-	-	-	-	-	-	-	-	-	7.5	14.5	7.3	14.2	96
104	-	-	-	-	-	-	-	-	-	-	-	-	5.7	12.1	104
112	-	-	-	-	-	-	-	-	-	-	-	-	4.3	10.5	112
1)	45.0	45.0	29.3	32.8	19.8	25.6	13.7	20.3	9.9	16.5	6.6	13.2	4.2	10.1	1)

ft	360°	Max.	360°	Max.	360°	Max.	360°	Max.	360°	Max.	360°	Max.	360°	Max.	ft
	134.8ft	134.8ft	148.3ft	148.3ft	161.4ft	161.4ft	174.9ft	174.9ft	188.6ft	188.6ft	202.1ft	202.1ft	223.1ft	223.1ft	
1,000 lb															
24	68.3	75.1	-	-	-	-	-	-	-	-	-	-	-	-	24
28	57.5	72.4	52.0	58.8	-	-	-	-	-	-	-	-	-	-	28
32	48.9	62.7	46.4	56.4	41.7	47.9	-	-	-	-	-	-	-	-	32
36	43.2	54.9	40.4	49.0	37.6	43.9	33.9	37.9	-	-	-	-	-	-	36
40	37.9	48.0	37.0	45.2	34.4	41.1	32.2	37.1	28.9	31.2	25.7	26.2	-	-	40
48	29.6	38.1	28.2	36.2	27.7	34.6	25.7	32.2	23.3	28.8	20.8	25.5	17.8	18.9	48
56	23.2	32.4	21.9	30.5	21.8	29.0	19.9	27.5	17.8	24.9	15.5	22.7	13.2	18.7	56
64	18.1	26.7	17.0	25.7	17.2	24.3	15.4	23.4	13.4	21.4	11.2	19.1	8.9	16.7	64
72	14.2	22.8	13.1	21.9	13.3	20.2	11.8	19.7	10.0	17.7	7.8	15.5	5.8	13.5	72
80	11.1	19.1	10.0	18.5	10.4	17.8	9.1	16.6	7.4	14.6	5.4	12.6	3.5	10.6	80
88	8.8	16.3	7.7	15.6	8.1	15.6	6.9	14.0	5.3	12.2	3.4	10.2	-	8.0	88
96	6.7	14.0	5.9	13.1	6.1	13.2	5.1	11.7	3.6	9.9	-	7.9	-	5.9	96
104	5.2	11.7	4.4	10.8	4.6	11.1	3.7	9.7	-	7.9	-	6.0	-	4.2	104
112	3.9	9.8	-	9.0	3.2	9.4	-	8.1	-	6.3	-	4.6	-	-	112
120	-	8.3	-	7.6	-	7.8	-	6.6	-	5.0	-	3.3	-	-	120
128	-	7.0	-	6.2	-	6.4	-	5.5	-	4.0	-	-	-	-	128
136	-	-	-	5.1	-	5.3	-	4.4	-	2.9	-	-	-	-	136
144	-	-	-	-	-	4.2	-	3.4	-	-	-	-	-	-	144
1)	-	7.7	-	4.9	-	3.3	-	-	-	-	-	-	-	-	1)

1) Capacities with horizontal boom

* Max. values are valid only for specific superstructure positions

8,200 lb		26.70 ft x 24.60 ft										360° / Max.*				85%
ft	360° 40.7ft	Max. 40.7ft	360° 54.1ft	Max. 54.1ft	360° 67.6ft	Max. 67.6ft	360° 81.0ft	Max. 81.0ft	360° 94.5ft	Max. 94.5ft	360° 107.9ft	Max. 107.9ft	360° 121.4ft	Max. 121.4ft	ft	
1,000 lb																
10	239.5	243.0	236.4	236.4	223.6	223.6	200.3	200.3	-	-	-	-	-	-	10	
12	216.2	222.0	215.4	215.4	207.8	207.8	196.5	196.5	157.0	157.0	-	-	-	-	12	
14	195.9	202.7	197.1	197.8	192.5	192.5	182.4	184.0	157.0	157.0	-	-	-	-	14	
16	174.0	180.3	176.0	180.8	170.8	177.7	156.1	172.6	140.8	157.0	120.7	120.7	-	-	16	
18	155.0	158.8	151.8	160.6	143.1	159.5	133.2	156.7	119.1	150.6	109.3	120.4	-	-	18	
20	135.7	139.1	130.7	140.8	120.7	141.0	112.7	142.8	105.2	141.4	95.8	119.7	86.2	95.2	20	
24	89.3	112.2	93.4	115.1	91.4	115.9	86.8	115.0	80.5	112.2	73.6	107.8	69.1	92.1	24	
28	62.2	93.2	69.2	96.0	71.0	96.7	68.6	94.1	63.9	95.7	61.7	88.3	57.8	77.1	28	
32	-	-	52.1	81.8	54.6	80.8	54.7	82.2	54.3	77.6	51.7	69.8	48.1	63.1	32	
36	-	-	41.9	68.4	44.1	70.1	44.5	70.2	46.1	64.9	43.7	58.6	41.6	55.0	36	
40	-	-	24.1	52.7	37.0	61.7	37.9	59.6	37.7	54.7	37.9	50.1	36.3	48.9	40	
48	-	-	-	-	26.4	44.9	27.3	44.5	27.9	41.4	28.2	41.4	27.7	37.5	48	
56	-	-	-	-	19.7	30.1	20.5	32.5	21.3	33.5	21.3	32.5	21.1	31.2	56	
64	-	-	-	-	-	-	15.6	26.3	16.5	26.4	16.5	26.0	16.3	26.3	64	
72	-	-	-	-	-	-	12.0	21.7	12.9	21.3	12.6	21.9	12.6	21.3	72	
80	-	-	-	-	-	-	-	-	10.0	18.3	10.0	18.5	9.8	18.1	80	
88	-	-	-	-	-	-	-	-	-	7.7	15.5	7.5	15.2	88		
96	-	-	-	-	-	-	-	-	-	6.0	13.1	5.8	12.9	96		
104	-	-	-	-	-	-	-	-	-	-	-	-	4.4	10.6	104	
112	-	-	-	-	-	-	-	-	-	-	-	-	3.2	9.0	112	
1)	45.0	45.0	25.8	32.8	17.4	25.6	11.7	20.3	8.4	16.1	5.3	11.9	3.1	8.8	1)	

ft	360° 134.8ft	Max. 134.8ft	360° 148.3ft	Max. 148.3ft	360° 161.4ft	Max. 161.4ft	360° 174.9ft	Max. 174.9ft	360° 188.6ft	Max. 188.6ft	360° 202.1ft	Max. 202.1ft	360° 223.1ft	Max. 223.1ft	ft
1,000 lb															
24	64.4	75.1	-	-	-	-	-	-	-	-	-	-	-	-	24
28	52.9	68.3	48.9	58.8	-	-	-	-	-	-	-	-	-	-	28
32	46.2	58.8	43.5	51.8	39.4	46.9	-	-	-	-	-	-	-	-	32
36	39.7	50.9	37.9	46.5	34.9	41.5	31.9	36.4	-	-	-	-	-	-	36
40	34.8	44.5	32.8	42.2	31.6	39.0	29.8	35.3	26.0	30.9	23.1	26.2	-	-	40
48	26.3	36.7	24.9	34.2	24.4	32.3	22.5	30.8	20.1	27.8	17.8	24.6	15.3	18.9	48
56	20.5	29.4	19.1	28.4	18.9	26.6	17.2	25.8	15.0	23.4	12.6	20.6	10.2	17.7	56
64	15.7	24.9	14.7	23.5	14.5	22.6	12.9	21.2	10.9	18.9	8.6	16.6	6.4	14.6	64
72	12.0	20.8	11.1	19.5	11.1	19.0	9.6	17.3	7.8	15.3	5.8	13.3	3.6	11.3	72
80	9.3	17.8	8.3	16.3	8.7	16.1	7.2	14.4	5.4	12.6	3.5	10.6	-	8.4	80
88	7.1	14.8	6.2	13.7	6.4	13.5	5.2	12.0	3.6	10.1	-	8.0	-	6.1	88
96	5.3	12.4	4.5	11.5	4.7	11.2	3.6	9.7	-	7.9	-	6.0	-	4.2	96
104	3.9	10.2	3.0	9.3	3.3	9.3	-	7.9	-	6.2	-	4.4	-	2.6	104
112	-	8.5	-	7.6	-	7.6	-	6.3	-	4.8	-	3.0	-	-	112
120	-	7.0	-	6.1	-	6.3	-	5.0	-	3.5	-	-	-	-	120
128	-	5.7	-	5.0	-	5.1	-	4.1	-	2.5	-	-	-	-	128
136	-	-	-	3.9	-	4.0	-	3.1	-	-	-	-	-	-	136
144	-	-	-	-	-	3.1	-	2.2	-	-	-	-	-	-	144
1)	-	5.7	-	3.5	-	2.4	-	-	-	-	-	-	-	-	1)

1) Capacities with horizontal boom



* Max. values are valid only for specific superstructure positions



101,400 lb		26.70 ft x 17.40 ft						360° / Max.*						85%	
ft	360° 40.7ft	Max. 40.7ft	360° 54.1ft	Max. 54.1ft	360° 67.6ft	Max. 67.6ft	360° 81.0ft	Max. 81.0ft	360° 94.5ft	Max. 94.5ft	360° 107.9ft	Max. 107.9ft	360° 121.4ft	Max. 121.4ft	ft
1,000 lb															
10	-	243.0	-	236.4	-	223.6	-	200.3	-	-	-	-	-	-	10
12	-	222.0	-	215.4	-	207.8	-	196.5	-	157.0	-	-	-	-	12
14	-	202.7	-	197.8	-	192.4	-	184.0	-	157.0	-	-	-	-	14
16	-	185.4	-	182.8	-	177.7	-	172.6	-	157.0	-	120.7	-	-	16
18	153.8	171.3	155.3	170.4	155.3	165.5	154.6	161.2	150.9	151.9	120.4	120.4	-	-	18
20	140.8	158.1	142.3	158.6	142.3	154.2	143.6	150.0	142.2	145.5	119.4	119.9	95.2	95.2	20
24	117.5	137.0	120.3	138.6	119.2	136.2	120.8	132.3	115.5	130.8	108.5	113.6	94.3	94.8	24
28	91.2	115.0	94.5	122.1	95.4	121.7	95.2	118.0	96.5	116.8	93.6	106.2	86.4	92.3	28
32	-	-	76.2	108.1	77.3	108.2	79.1	106.5	78.5	105.5	77.4	98.0	74.1	88.9	32
36	-	-	64.8	95.8	66.8	95.7	66.9	94.9	66.4	95.0	65.3	92.0	63.4	83.8	36
40	-	-	48.5	79.3	56.4	84.0	56.4	85.4	56.0	84.7	54.9	85.4	54.2	78.3	40
48	-	-	-	-	43.1	67.4	43.3	67.0	42.8	67.4	42.9	67.7	43.1	65.9	48
56	-	-	-	-	30.1	45.4	34.4	53.4	34.8	54.4	35.1	53.3	34.2	51.6	56
64	-	-	-	-	-	-	28.0	44.8	29.2	44.2	28.7	43.1	27.9	41.5	64
72	-	-	-	-	-	-	24.5	30.1	24.6	36.8	23.9	35.7	24.5	34.2	72
80	-	-	-	-	-	-	-	-	20.9	30.4	20.8	30.1	20.9	31.1	80
88	-	-	-	-	-	-	-	-	-	-	18.4	26.8	17.9	27.1	88
96	-	-	-	-	-	-	-	-	-	-	16.1	23.1	15.6	23.5	96
104	-	-	-	-	-	-	-	-	-	-	-	-	14.1	20.6	104
112	-	-	-	-	-	-	-	-	-	-	-	-	11.9	11.9	112
1)	45.0	45.0	32.8	32.8	25.6	26.5	20.3	20.3	16.5	16.5	13.2	13.2	10.6	10.6	1)

ft	360° 134.8ft	Max. 134.8ft	360° 148.3ft	Max. 148.3ft	360° 161.4ft	Max. 161.4ft	360° 174.9ft	Max. 174.9ft	360° 188.6ft	Max. 188.6ft	360° 202.1ft	Max. 202.1ft	360° 223.1ft	Max. 223.1ft	ft
1,000 lb															
24	75.1	75.1	-	-	-	-	-	-	-	-	-	-	-	-	24
28	72.4	72.4	58.8	58.8	-	-	-	-	-	-	-	-	-	-	28
32	68.5	68.6	57.5	57.5	47.9	47.9	-	-	-	-	-	-	-	-	32
36	60.8	64.4	54.9	55.3	46.7	46.7	37.9	37.9	-	-	-	-	-	-	36
40	54.5	60.2	51.2	52.7	45.3	45.4	37.7	37.7	31.3	31.3	26.2	26.2	-	-	40
48	41.7	52.1	40.0	46.8	39.3	41.7	36.4	36.9	31.0	31.0	25.8	25.8	18.9	18.9	48
56	33.5	44.8	33.4	41.1	31.8	37.5	31.4	34.4	29.8	30.2	25.8	25.8	18.7	18.7	56
64	28.3	40.2	27.4	35.9	27.3	33.2	27.1	31.3	26.1	28.5	25.1	25.3	18.7	18.7	64
72	23.7	35.4	23.7	31.4	23.4	29.4	23.0	28.1	21.9	26.5	21.6	24.1	18.7	18.7	72
80	20.5	29.9	20.0	27.5	19.8	26.0	19.3	24.9	19.4	24.1	18.5	22.5	17.6	18.7	80
88	17.8	25.6	17.5	24.9	17.0	23.0	16.9	22.1	16.5	21.7	15.6	20.8	14.8	17.9	88
96	15.4	22.1	15.2	22.5	14.5	20.6	14.8	19.7	14.1	19.4	13.2	19.0	12.6	16.9	96
104	13.8	19.6	13.2	19.7	13.0	18.5	12.8	17.6	12.1	17.4	11.3	17.2	10.6	15.6	104
112	12.0	18.4	11.6	17.1	11.6	17.3	11.2	16.0	10.5	15.6	9.6	15.5	8.9	14.0	112
120	10.7	16.5	10.1	15.0	10.3	15.2	9.6	14.7	9.0	14.2	8.3	13.7	7.5	12.7	120
128	9.5	11.0	8.9	14.0	9.0	13.3	8.4	13.1	7.8	12.6	7.0	11.8	6.3	11.5	128
136	-	-	7.9	13.0	8.0	11.8	7.3	11.4	6.8	10.9	6.0	10.4	4.9	10.1	136
144	-	-	-	-	7.1	10.8	6.4	10.0	5.8	9.5	4.7	9.5	3.8	8.4	144
152	-	-	-	-	-	-	5.6	9.2	4.9	8.2	3.8	8.2	2.8	7.3	152
160	-	-	-	-	-	-	4.8	8.3	3.9	7.2	2.8	7.2	-	6.1	160
168	-	-	-	-	-	-	-	-	3.2	6.6	-	6.1	-	5.0	168
176	-	-	-	-	-	-	-	-	2.5	6.2	-	5.2	-	4.1	176
184	-	-	-	-	-	-	-	-	-	-	-	4.4	-	3.4	184
1)	7.9	7.9	6.0	5.0	4.9	4.9	2.9	2.9	-	-	-	-	-	-	1)

1) Capacities with horizontal boom

* Max. values are valid only for specific superstructure positions

		71,900 lb																	
		26.70 ft x 17.40 ft																	
		360° / Max.*																85%	
		360°	Max.	360°	Max.	360°	Max.	360°	Max.	360°	Max.	360°	Max.	360°	Max.	360°	Max.		
ft	ft	40.7ft	40.7ft	54.1ft	54.1ft	67.6ft	67.6ft	81.0ft	81.0ft	94.5ft	94.5ft	107.9ft	107.9ft	121.4ft	121.4ft	ft	ft		
		1,000 lb																	
10		225.1	243.0	226.2	236.4	223.2	223.6	200.3	200.3	-	-	-	-	-	-	-	-	10	
12		200.7	222.0	202.1	215.4	202.1	207.8	196.5	196.5	157.0	157.0	-	-	-	-	-	-	12	
14		180.4	202.7	181.8	197.8	181.8	192.4	179.1	184.0	157.0	157.0	-	-	-	-	-	-	14	
16		163.5	185.4	164.8	182.8	164.8	177.7	157.6	172.6	143.5	157.0	120.7	120.7	-	-	-	-	16	
18		146.7	171.3	148.6	170.4	146.9	165.5	139.5	161.2	126.3	151.9	114.2	120.4	-	-	-	-	18	
20		129.1	158.1	133.6	158.6	131.9	154.2	121.6	150.0	115.7	145.5	106.0	119.9	94.0	95.2	-	-	20	
24		92.2	136.3	96.1	137.9	97.1	135.8	99.6	132.3	93.9	130.8	86.6	113.6	79.2	94.8	-	-	24	
28		70.4	114.1	75.0	117.5	76.8	117.4	77.1	116.2	76.3	116.0	72.5	106.2	67.6	92.3	-	-	28	
32		-	-	60.1	100.9	61.7	100.2	62.0	101.7	61.3	100.8	60.1	97.9	60.2	88.9	-	-	32	
36		-	-	50.5	88.9	52.0	87.8	52.2	89.2	51.6	88.3	51.6	88.6	52.0	83.6	-	-	36	
40		-	-	35.8	72.3	43.6	78.5	43.8	78.1	45.2	79.2	44.7	78.7	43.6	77.4	-	-	40	
48		-	-	-	-	33.6	63.2	34.4	62.8	34.4	64.3	33.9	63.4	34.5	62.1	-	-	48	
56		-	-	-	-	26.7	44.6	27.4	52.9	27.2	52.7	27.7	51.5	27.3	50.0	-	-	56	
64		-	-	-	-	-	-	22.3	44.1	22.5	43.3	22.6	42.2	22.5	40.5	-	-	64	
72		-	-	-	-	-	-	18.4	29.5	18.8	36.7	18.8	35.6	18.8	34.2	-	-	72	
80		-	-	-	-	-	-	-	-	15.9	30.0	15.9	29.7	15.9	30.9	-	-	80	
88		-	-	-	-	-	-	-	-	-	-	13.6	26.8	13.5	26.8	-	-	88	
96		-	-	-	-	-	-	-	-	-	-	11.7	23.1	11.6	23.3	-	-	96	
104		-	-	-	-	-	-	-	-	-	-	-	-	9.9	20.2	-	-	104	
112		-	-	-	-	-	-	-	-	-	-	-	-	8.5	11.9	-	-	112	
1)		45.0	45.0	32.8	32.8	24.5	25.6	18.1	20.3	14.1	16.5	10.8	13.2	8.6	10.6	-	-	1)	

		360°	Max.	360°	Max.	360°	Max.	360°	Max.	360°	Max.	360°	Max.	360°	Max.		
ft	ft	134.8ft	134.8ft	148.3ft	148.3ft	161.4ft	161.4ft	174.9ft	174.9ft	188.6ft	188.6ft	202.1ft	202.1ft	223.1ft	223.1ft	ft	
		1,000 lb															
24		72.6	75.1	-	-	-	-	-	-	-	-	-	-	-	-	24	
28		63.6	72.4	56.8	58.8	-	-	-	-	-	-	-	-	-	-	28	
32		55.7	68.6	51.5	57.5	46.7	47.9	-	-	-	-	-	-	-	-	32	
36		48.8	64.4	46.4	55.3	41.9	46.7	37.1	37.9	-	-	-	-	-	-	36	
40		42.5	60.2	41.7	52.7	39.1	45.4	35.5	37.7	31.1	31.3	26.2	26.2	-	-	40	
48		33.6	52.1	33.6	46.8	32.3	41.7	31.7	36.9	28.5	31.0	25.4	25.8	18.9	18.9	48	
56		27.1	44.8	26.8	41.1	26.3	37.5	25.9	34.4	24.5	30.2	22.4	25.8	18.7	18.7	56	
64		22.1	40.2	21.6	35.9	21.8	33.2	21.2	31.3	20.5	28.5	19.1	25.3	16.9	18.7	64	
72		18.4	35.4	17.7	31.4	17.9	29.4	17.3	28.1	16.6	26.5	15.7	24.1	14.0	18.7	72	
80		15.5	29.2	14.8	27.2	15.1	25.9	14.4	24.9	13.7	24.1	12.8	22.5	11.3	18.7	80	
88		13.2	25.3	12.5	24.9	12.7	23.0	12.1	22.1	11.4	21.7	10.5	20.8	9.2	17.9	88	
96		11.2	21.8	10.6	22.4	10.7	20.3	10.2	19.4	9.5	19.4	8.6	19.0	7.3	16.9	96	
104		9.6	19.6	9.0	19.3	9.2	18.5	8.6	17.6	7.9	17.1	7.0	17.2	5.7	15.6	104	
112		8.3	18.4	7.7	17.1	7.9	17.3	7.2	16.0	6.6	15.6	5.7	15.5	4.3	14.0	112	
120		7.1	16.5	6.6	15.0	6.6	15.2	6.1	14.7	5.4	14.2	4.3	13.7	3.1	12.6	120	
128		6.2	11.0	5.6	14.0	5.7	13.3	5.1	13.1	4.2	12.4	3.1	11.7	-	11.1	128	
136		-	-	4.8	13.0	4.8	11.6	4.0	11.4	3.3	10.9	-	10.4	-	9.9	136	
144		-	-	-	-	4.0	10.8	3.1	10.0	2.3	9.5	-	9.5	-	8.4	144	
152		-	-	-	-	-	-	-	9.2	-	8.2	-	8.2	-	6.9	152	
160		-	-	-	-	-	-	-	8.3	-	7.2	-	6.7	-	6.0	160	
168		-	-	-	-	-	-	-	-	-	6.6	-	5.8	-	4.9	168	
176		-	-	-	-	-	-	-	-	-	6.2	-	5.2	-	4.1	176	
184		-	-	-	-	-	-	-	-	-	-	-	4.4	-	3.2	184	
1)		6.2	7.9	4.4	6.0	3.1	4.9	-	2.9	-	-	-	-	-	-	1)	

1) Capacities with horizontal boom

* Max. values are valid only for specific superstructure positions

56,000 lb		26.70 ft x 17.40 ft								360° / Max.*				85%	
ft	360° 40.7ft	Max. 40.7ft	360° 54.1ft	Max. 54.1ft	360° 67.6ft	Max. 67.6ft	360° 81.0ft	Max. 81.0ft	360° 94.5ft	Max. 94.5ft	360° 107.9ft	Max. 107.9ft	360° 121.4ft	Max. 121.4ft	ft
1,000 lb															
10	221.8	243.0	222.9	236.4	222.9	223.6	200.3	200.3	-	-	-	-	-	-	10
12	197.9	222.0	199.2	215.4	199.2	207.8	190.2	196.5	156.3	157.0	-	-	-	-	12
14	177.8	202.7	179.2	197.8	175.8	192.4	162.0	184.0	144.2	157.0	-	-	-	-	14
16	161.2	185.4	162.5	182.8	150.2	177.7	137.5	172.6	125.6	157.0	114.9	120.7	-	-	16
18	136.4	171.3	139.0	170.4	132.3	165.5	119.9	161.2	113.1	151.9	102.7	120.4	-	-	18
20	110.7	157.8	115.3	158.4	113.4	154.2	108.4	150.0	99.4	145.5	90.7	119.9	83.4	95.2	20
24	78.7	132.3	83.5	134.0	86.0	133.9	85.6	130.9	80.3	130.3	73.8	113.6	69.6	94.8	24
28	59.6	110.4	64.2	111.9	66.0	111.9	66.2	113.4	65.4	112.4	63.3	106.2	60.2	92.3	28
32	-	-	51.2	96.5	52.8	96.1	53.0	97.0	53.8	95.9	54.1	96.0	51.5	88.9	32
36	-	-	42.8	84.7	44.3	85.2	44.5	85.0	46.1	85.0	45.5	85.7	43.9	80.8	36
40	-	-	29.0	68.8	38.0	74.5	38.9	74.3	38.7	75.9	38.2	74.9	38.7	71.6	40
48	-	-	-	-	28.6	58.0	29.4	59.9	29.6	59.5	29.7	58.3	29.7	55.2	48
56	-	-	-	-	22.5	38.8	23.0	47.8	23.5	47.1	23.7	46.0	23.4	44.1	56
64	-	-	-	-	-	-	18.5	39.3	19.1	38.6	19.1	37.5	18.9	37.5	64
72	-	-	-	-	-	-	15.3	28.7	15.7	31.9	15.7	31.6	15.5	32.1	72
80	-	-	-	-	-	-	-	-	13.1	27.2	13.1	28.4	12.9	27.5	80
88	-	-	-	-	-	-	-	-	-	-	11.1	24.4	10.8	23.3	88
96	-	-	-	-	-	-	-	-	-	-	9.3	21.0	9.2	19.9	96
104	-	-	-	-	-	-	-	-	-	-	-	-	7.9	17.8	104
112	-	-	-	-	-	-	-	-	-	-	-	-	6.6	11.9	112
1)	45.0	45.0	28.9	32.8	20.3	25.6	15.0	20.3	11.5	16.5	8.6	13.2	6.6	10.6	1)

ft	360° 134.8ft	Max. 134.8ft	360° 148.3ft	Max. 148.3ft	360° 161.4ft	Max. 161.4ft	360° 174.9ft	Max. 174.9ft	360° 188.6ft	Max. 188.6ft	360° 202.1ft	Max. 202.1ft	360° 223.1ft	Max. 223.1ft	ft
1,000 lb															
24	65.0	75.1	-	-	-	-	-	-	-	-	-	-	-	-	24
28	55.7	72.4	51.1	58.8	-	-	-	-	-	-	-	-	-	-	28
32	48.9	68.6	45.9	57.5	41.7	47.9	-	-	-	-	-	-	-	-	32
36	43.3	64.4	40.9	55.3	38.1	46.7	34.3	37.9	-	-	-	-	-	-	36
40	37.8	60.2	37.4	52.7	35.3	45.4	33.2	37.7	29.3	31.3	26.0	26.2	-	-	40
48	29.1	51.6	28.8	46.8	28.5	41.7	27.6	36.9	24.8	31.0	22.0	25.8	18.7	18.9	48
56	23.2	43.9	22.5	40.3	22.7	37.5	22.0	34.4	20.4	30.2	18.3	25.8	16.4	18.7	56
64	18.7	37.3	17.8	33.9	18.2	32.3	17.6	31.3	16.6	28.5	14.8	25.3	13.0	18.7	64
72	15.3	30.5	14.4	29.4	14.6	28.1	14.2	26.5	13.3	26.5	11.7	24.1	10.2	18.7	72
80	12.7	26.0	12.0	26.1	12.2	23.5	11.6	23.7	10.9	22.6	9.4	22.2	7.9	18.7	80
88	10.6	23.0	9.9	22.3	10.2	21.6	9.5	20.7	8.8	20.3	7.5	19.1	6.0	17.7	88
96	8.9	20.5	8.2	18.8	8.4	19.2	7.8	18.5	7.1	17.6	5.8	16.6	4.2	15.4	96
104	7.4	17.7	6.8	17.4	7.0	16.4	6.3	16.0	5.7	15.0	4.4	14.4	2.8	12.9	104
112	6.3	15.3	5.7	15.3	5.9	14.5	5.2	14.4	4.3	13.1	3.0	12.5	-	10.7	112
120	5.3	13.6	4.6	13.2	4.8	13.2	3.9	12.1	3.3	11.7	-	10.9	-	9.3	120
128	4.4	11.0	3.6	11.5	3.7	11.2	3.0	10.9	-	10.4	-	9.2	-	7.8	128
136	-	-	2.8	10.4	2.8	9.6	-	9.8	-	8.9	-	7.8	-	6.5	136
144	-	-	-	-	-	8.4	-	8.4	-	7.6	-	6.5	-	5.1	144
152	-	-	-	-	-	-	-	7.4	-	6.5	-	5.4	-	4.1	152
160	-	-	-	-	-	-	-	6.4	-	5.6	-	4.3	-	3.3	160
168	-	-	-	-	-	-	-	-	-	4.7	-	3.4	-	-	168
176	-	-	-	-	-	-	-	-	-	3.9	-	2.7	-	-	176
1)	4.4	7.9	2.4	6.0	-	4.9	-	2.9	-	-	-	-	-	-	1)

1) Capacities with horizontal boom

* Max. values are valid only for specific superstructure positions

13,900 lb		26.70 ft x 17.40 ft								360° / Max.*				85%	
ft	360° 40.7ft	Max. 40.7ft	360° 54.1ft	Max. 54.1ft	360° 67.6ft	Max. 67.6ft	360° 81.0ft	Max. 81.0ft	360° 94.5ft	Max. 94.5ft	360° 107.9ft	Max. 107.9ft	360° 121.4ft	Max. 121.4ft	ft
1,000 lb															
10	213.9	243.0	206.5	236.4	172.6	223.6	143.6	200.3	-	-	-	-	-	-	10
12	178.3	222.0	153.6	215.4	131.7	207.8	118.7	196.5	103.0	157.0	-	-	-	-	12
14	133.1	202.7	119.0	197.8	109.3	192.4	97.1	184.0	87.4	157.0	-	-	-	-	14
16	100.2	182.9	98.5	182.8	90.3	177.7	81.4	172.6	76.7	157.0	68.9	120.7	-	-	16
18	78.4	162.1	81.7	163.5	77.3	160.9	70.9	158.1	67.1	150.1	61.7	120.4	-	-	18
20	60.3	142.1	66.6	143.8	65.8	143.8	63.5	143.8	58.5	139.5	55.3	117.9	51.4	94.8	20
24	41.4	114.6	46.7	117.6	50.3	115.0	49.6	111.7	47.8	106.9	44.5	98.4	41.9	85.2	24
28	30.2	90.3	34.7	94.7	37.9	91.8	38.9	90.8	38.8	84.7	36.7	77.0	34.8	69.9	28
32	-	-	26.9	75.0	29.8	76.5	30.6	75.4	31.4	69.6	30.7	62.5	29.2	59.4	32
36	-	-	21.8	62.6	24.6	64.6	25.2	63.0	26.1	58.3	25.9	53.4	25.0	51.5	36
40	-	-	11.0	42.5	20.0	54.9	20.7	52.0	21.5	48.3	21.5	48.1	21.1	44.0	40
48	-	-	-	-	14.3	37.7	14.9	37.9	15.6	38.7	15.6	36.3	15.4	34.9	48
56	-	-	-	-	10.5	28.4	10.9	29.5	11.6	29.4	11.6	28.6	11.5	28.6	56
64	-	-	-	-	-	-	8.2	23.1	8.9	23.2	8.9	23.4	8.6	23.0	64
72	-	-	-	-	-	-	6.2	18.8	6.7	19.2	6.7	19.3	6.7	19.0	72
80	-	-	-	-	-	-	-	-	5.1	16.1	5.1	15.9	5.0	15.8	80
88	-	-	-	-	-	-	-	-	-	-	3.7	13.3	3.5	13.1	88
96	-	-	-	-	-	-	-	-	-	-	-	11.2	-	10.9	96
104	-	-	-	-	-	-	-	-	-	-	-	-	-	9.1	104
112	-	-	-	-	-	-	-	-	-	-	-	-	-	7.6	112
1)	22.7	45.0	13.4	32.8	9.0	25.6	6.2	18.5	4.0	13.9	-	10.1	-	7.5	1)

ft	360° 134.8ft	Max. 134.8ft	360° 148.3ft	Max. 148.3ft	360° 161.4ft	Max. 161.4ft	360° 174.9ft	Max. 174.9ft	360° 188.6ft	Max. 188.6ft	360° 202.1ft	Max. 202.1ft	360° 223.1ft	Max. 223.1ft	ft
1,000 lb															
24	38,2	73,0	-	-	-	-	-	-	-	-	-	-	-	-	24
28	31,7	63,7	29,6	56,0	-	-	-	-	-	-	-	-	-	-	28
32	26,7	54,1	24,9	50,3	24,2	45,0	-	-	-	-	-	-	-	-	32
36	22,9	46,7	21,3	43,8	20,8	39,5	18,6	34,9	-	-	-	-	-	-	36
40	19,5	42,2	18,1	39,1	17,7	36,5	15,8	34,2	13,8	30,0	10,7	26,1	-	-	40
48	14,8	32,7	13,6	32,2	13,2	30,1	11,7	28,7	9,7	25,2	7,8	22,9	-	18,9	48
56	11,2	27,0	10,0	25,6	9,9	25,1	8,5	23,5	6,9	21,4	5,1	18,9	-	16,7	56
64	8,4	22,2	7,3	20,9	7,3	20,7	6,0	19,1	4,6	17,3	2,7	15,3	-	13,2	64
72	6,2	18,6	5,3	17,3	5,3	17,1	4,0	15,5	2,5	14,0	-	12,0	-	10,0	72
80	4,6	15,4	3,7	14,5	3,8	14,2	-	12,6	-	11,0	-	9,1	-	7,3	80
88	3,1	12,6	-	11,8	-	12,1	-	10,5	-	8,7	-	6,9	-	5,1	88
96	-	10,5	-	9,6	-	9,9	-	8,7	-	7,0	-	5,1	-	3,4	96
104	-	8,6	-	7,7	-	7,9	-	7,0	-	5,5	-	3,5	-	-	104
112	-	7,0	-	6,3	-	6,5	-	5,7	-	4,1	-	-	-	-	112
120	-	5,9	-	5,0	-	5,3	-	4,4	-	3,1	-	-	-	-	120
128	-	4,7	-	4,0	-	4,2	-	3,3	-	-	-	-	-	-	128
136	-	-	-	3,0	-	3,1	-	2,4	-	-	-	-	-	-	136
144	-	-	-	-	-	2,2	-	-	-	-	-	-	-	-	144
1)	-	4.9	-	2.6	-	-	-	-	-	-	-	-	-	-	1)

1) Capacities with horizontal boom

* Max. values are valid only for specific superstructure positions

8,200 lb		26.70 ft x 17.40 ft										360° / Max.*				85%
ft	360° 40.7ft	Max. 40.7ft	360° 54.1ft	Max. 54.1ft	360° 67.6ft	Max. 67.6ft	360° 81.0ft	Max. 81.0ft	360° 94.5ft	Max. 94.5ft	360° 107.9ft	Max. 107.9ft	360° 121.4ft	Max. 121.4ft	ft	
1,000 lb																
10	211.2	243.0	190.4	236.4	156.0	223.6	136.0	200.3	-	-	-	-	-	-	10	
12	160.7	222.0	138.3	215.4	123.2	207.8	107.2	196.5	94.5	157.0	-	-	-	-	12	
14	118.8	202.7	108.0	197.8	98.4	192.4	87.5	184.0	81.2	157.0	-	-	-	-	14	
16	89.5	180.3	88.4	180.8	81.1	177.7	75.5	172.6	69.0	157.0	61.9	120.7	-	-	16	
18	70.0	158.8	73.3	160.6	69.4	159.5	66.0	154.3	60.3	144.2	56.4	119.2	-	-	18	
20	53.6	139.1	59.7	140.8	60.4	140.3	56.9	141.1	53.7	127.8	49.4	115.5	46.2	93.9	20	
24	36.4	111.7	41.6	113.0	45.2	109.5	44.5	104.6	42.7	100.3	39.7	89.9	37.4	78.1	24	
28	26.2	84.5	30.8	88.3	33.9	86.0	34.8	86.1	34.6	77.2	32.6	68.9	30.8	64.3	28	
32	-	-	23.6	71.7	26.4	72.5	27.3	68.1	28.1	62.7	27.2	58.3	25.7	54.4	32	
36	-	-	18.9	58.7	21.6	59.9	22.5	56.3	23.2	52.0	22.8	50.8	21.9	46.5	36	
40	-	-	8.6	36.7	17.4	49.1	18.3	47.2	18.9	45.7	18.9	42.9	18.5	40.6	40	
48	-	-	-	-	12.3	34.5	12.8	34.6	13.5	35.4	13.5	32.9	13.5	32.1	48	
56	-	-	-	-	8.8	25.9	9.4	26.6	9.9	26.4	9.9	27.0	9.9	26.3	56	
64	-	-	-	-	-	-	6.9	21.0	7.5	21.5	7.5	21.8	7.3	21.3	64	
72	-	-	-	-	-	-	5.1	16.8	5.6	17.5	5.6	17.5	5.3	17.3	72	
80	-	-	-	-	-	-	-	-	4.0	14.4	4.0	14.3	3.8	14.1	80	
88	-	-	-	-	-	-	-	-	-	-	-	11.8	-	11.6	88	
96	-	-	-	-	-	-	-	-	-	-	-	9.8	-	9.6	96	
104	-	-	-	-	-	-	-	-	-	-	-	-	-	7.9	104	
112	-	-	-	-	-	-	-	-	-	-	-	-	-	6.5	112	
1)	19.4	45.0	11.2	32.8	7.5	23.4	4.9	16.8	2.9	12.3	-	8.8	-	6.2	1)	

ft	360° 134.8ft	Max. 134.8ft	360° 148.3ft	Max. 148.3ft	360° 161.4ft	Max. 161.4ft	360° 174.9ft	Max. 174.9ft	360° 188.6ft	Max. 188.6ft	360° 202.1ft	Max. 202.1ft	360° 223.1ft	Max. 223.1ft	ft
1,000 lb															
24	34.0	69.0	-	-	-	-	-	-	-	-	-	-	-	-	24
28	28.0	59.3	25.9	52.5	-	-	-	-	-	-	-	-	-	-	28
32	23.4	49.3	21.7	46.6	21.0	41.7	-	-	-	-	-	-	-	-	32
36	19.9	43.8	18.5	40.9	17.9	37.5	15.9	33.7	-	-	-	-	-	-	36
40	16.8	38.4	15.5	37.4	15.1	34.3	13.4	31.8	11.4	29.2	8.3	25.8	-	-	40
48	12.5	30.6	11.2	29.2	11.1	28.6	9.5	26.2	7.8	23.5	5.8	21.3	-	18.1	48
56	9.3	24.5	8.1	23.3	8.1	22.9	6.7	21.1	5.1	19.0	-	16.4	-	14.5	56
64	6.8	20.0	5.7	18.7	5.7	18.5	4.4	17.1	2.9	15.3	-	13.2	-	11.0	64
72	4.9	16.4	3.8	15.3	3.8	15.1	2.5	13.7	-	12.0	-	10.0	-	8.0	72
80	3.3	13.9	-	12.6	-	12.3	-	10.9	-	9.1	-	7.4	-	5.6	80
88	-	11.2	-	10.3	-	10.4	-	8.8	-	7.1	-	5.3	-	3.6	88
96	-	9.2	-	8.3	-	8.5	-	7.1	-	5.3	-	3.6	-	-	96
104	-	7.5	-	6.6	-	6.8	-	5.7	-	3.9	-	-	-	-	104
112	-	5.9	-	5.2	-	5.4	-	4.3	-	-	-	-	-	-	112
120	-	4.8	-	3.9	-	4.2	-	3.3	-	-	-	-	-	-	120
128	-	3.7	-	3.0	-	3.1	-	-	-	-	-	-	-	-	128
1)	-	3.7	-	-	-	-	-	-	-	-	-	-	-	-	1)

1) Capacities with horizontal boom

* Max. values are valid only for specific superstructure positions





8,200 lb		26.70 ft x 8.30 ft										360° / Max.*				85%
ft	360° 40.7ft	Max. 40.7ft	360° 54.1ft	Max. 54.1ft	360° 67.6ft	Max. 67.6ft	360° 81.0ft	Max. 81.0ft	360° 94.5ft	Max. 94.5ft	360° 107.9ft	Max. 107.9ft	360° 121.4ft	Max. 121.4ft	ft	
10	56.7	243.0	55.3	236.4	52.6	170.6	48.3	107.3	-	-	-	-	-	-	10	
12	42.9	222.0	44.7	215.4	43.4	171.9	40.3	109.0	36.2	78.7	-	-	-	-	12	
14	31.6	202.7	36.3	197.8	36.3	176.1	34.0	110.8	32.1	79.5	-	-	-	-	14	
16	24.1	180.3	29.0	180.8	30.8	175.7	29.1	112.9	27.7	80.5	23.4	59.6	-	-	16	
18	19.2	158.8	23.7	160.6	26.1	159.0	25.3	114.1	24.3	78.1	22.1	61.1	-	-	18	
20	15.0	139.1	19.1	140.2	22.0	138.3	21.8	113.7	21.2	79.3	19.3	61.0	18.0	49.4	20	
24	9.5	108.1	13.4	108.4	16.0	99.1	16.7	95.3	16.4	78.8	15.2	62.4	14.2	49.7	24	
28	5.4	75.8	9.6	78.0	11.9	77.2	12.6	72.2	13.0	66.4	12.1	61.3	11.2	49.5	28	
32	-	-	6.7	59.7	8.9	60.6	9.6	57.1	10.2	54.8	9.5	52.5	8.8	47.9	32	
36	-	-	4.3	46.8	6.9	48.4	7.5	47.1	8.2	47.1	7.6	44.0	7.0	41.6	36	
40	-	-	-	27.6	5.0	39.3	5.7	40.2	6.4	39.4	6.0	38.0	5.3	36.3	40	
48	-	-	-	-	-	28.2	-	28.6	3.6	29.2	3.4	28.9	-	28.3	48	
56	-	-	-	-	-	21.5	-	22.1	-	22.5	-	22.2	-	22.1	56	
64	-	-	-	-	-	-	-	17.4	-	17.8	-	17.6	-	17.4	64	
72	-	-	-	-	-	-	-	14.2	-	14.4	-	14.2	-	13.9	72	
80	-	-	-	-	-	-	-	-	-	11.7	-	11.6	-	11.3	80	
88	-	-	-	-	-	-	-	-	-	-	-	9.4	-	9.1	88	
96	-	-	-	-	-	-	-	-	-	-	-	7.5	-	7.3	96	
104	-	-	-	-	-	-	-	-	-	-	-	-	-	5.9	104	
112	-	-	-	-	-	-	-	-	-	-	-	-	-	4.6	112	
1)	2.2	45.0	-	28.7	-	19.6	-	13.9	-	10.1	-	7.1	-	4.6	1)	



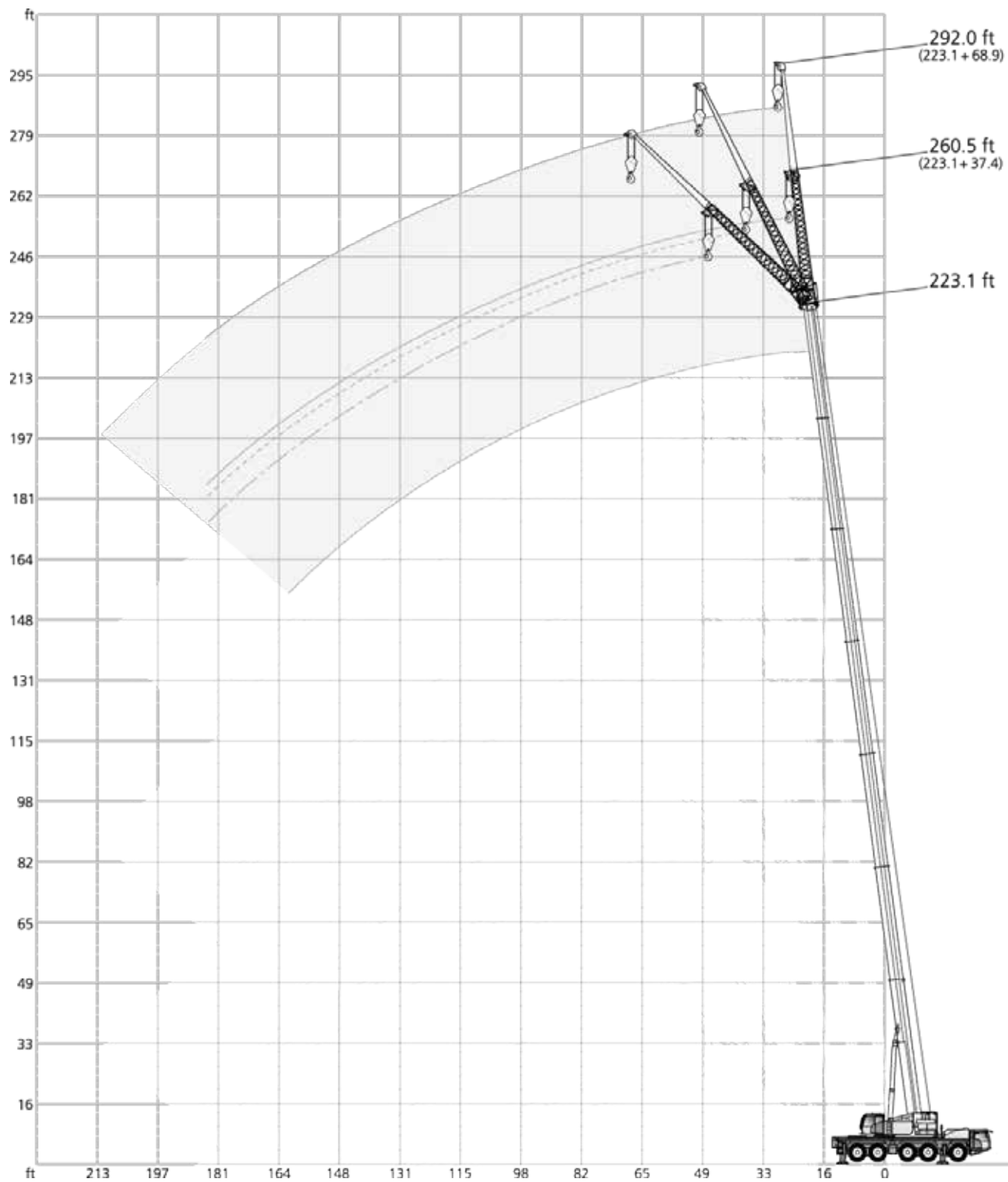

ft	360° 134.8ft	Max. 134.8ft	360° 148.3ft	Max. 148.3ft	360° 161.4ft	Max. 161.4ft	360° 174.9ft	Max. 174.9ft	360° 188.6ft	Max. 188.6ft	360° 202.1ft	Max. 202.1ft	360° 223.1ft	Max. 223.1ft	ft
24	12.0	39.6	-	-	-	-	-	-	-	-	-	-	-	-	24
28	9.5	40.3	8.2	32.7	-	-	-	-	-	-	-	-	-	-	28
32	7.4	41.1	6.1	33.2	6.1	28.2	-	-	-	-	-	-	-	-	32
36	5.8	38.2	4.6	33.4	4.6	28.5	-	23.1	-	-	-	-	-	-	36
40	4.2	34.4	-	32.9	-	28.6	-	23.4	-	17.9	-	13.3	-	-	40
48	-	26.7	-	25.4	-	24.9	-	22.8	-	18.2	-	13.8	-	10.0	48
56	-	21.2	-	19.9	-	19.8	-	18.2	-	16.3	-	13.4	-	10.3	56
64	-	17.0	-	15.9	-	15.8	-	14.4	-	12.6	-	10.6	-	8.5	64
72	-	13.3	-	12.4	-	12.6	-	11.1	-	9.3	-	7.6	-	5.8	72
80	-	10.9	-	9.8	-	10.0	-	8.7	-	7.2	-	5.2	-	3.5	80
88	-	8.6	-	7.7	-	7.8	-	6.6	-	5.2	-	3.4	-	-	88
96	-	6.7	-	6.0	-	6.2	-	5.0	-	3.6	-	-	-	-	96
104	-	5.4	-	4.4	-	4.6	-	3.7	-	2.3	-	-	-	-	104
112	-	4.1	-	3.2	-	3.5	-	-	-	-	-	-	-	-	112
120	-	3.1	-	-	-	-	-	-	-	-	-	-	-	-	120
1)	-	2.2	-	-	-	-	-	-	-	-	-	-	-	-	1)





1) Capacities with horizontal boom





* Max. values are valid only for specific superstructure positions



101,400 lb		26.70 ft x 24.60 ft		360°		85%	
 40.7 ft							
  37.4 ft							
  68.9 ft							
ft	0°	20°	40°	0°	20°	40°	1,000 lb
10	41.2	-	-	22.2	-	-	
12	41.2	-	-	22.0	-	-	
14	41.2	-	-	21.9	-	-	
16	41.2	-	-	21.7	-	-	
18	41.2	-	-	21.4	-	-	
20	41.2	34.8	-	21.1	-	-	
24	41.2	31.9	-	20.5	-	-	
28	39.6	29.5	-	19.7	-	-	
32	35.8	27.5	22.5	18.9	-	-	
36	32.7	25.8	21.5	17.9	-	-	
40	29.9	24.3	20.6	16.8	13.6	-	
48	25.7	21.7	19.3	14.9	12.3	-	
56	22.3	19.9	18.6	13.2	11.2	9.7	
64	19.8	18.7	-	11.7	10.3	9.1	
72	-	-	-	10.6	9.5	8.6	
80	-	-	-	9.8	9.0	8.3	
88	-	-	-	9.1	8.5	8.2	
96	-	-	-	8.5	8.2	-	

 121.4 ft							
  37.4 ft							
  68.9 ft							
ft	0°	20°	40°	0°	20°	40°	1,000 lb
24	39.0	-	-	-	-	-	
28	38.6	-	-	16.6	-	-	
32	38.2	-	-	16.4	-	-	
36	37.7	-	-	16.1	-	-	
40	37.2	29.2	-	15.9	-	-	
48	35.6	27.3	21.4	15.5	-	-	
56	33.0	25.5	20.6	15.1	12.8	-	
64	30.1	23.9	20.0	14.7	12.1	-	
72	27.4	22.5	19.4	14.1	11.5	-	
80	25.3	21.2	18.9	13.8	10.9	9.0	
88	23.5	20.1	18.3	13.3	10.4	8.7	
96	21.9	19.1	17.8	12.7	9.9	8.5	
104	20.6	18.2	17.3	12.0	9.5	8.4	
112	18.4	17.4	17.0	11.2	9.2	8.2	
120	16.0	16.5	16.5	10.7	9.0	8.1	
128	13.9	14.5	7.6	10.1	8.7	7.9	
136	12.3	12.5	-	9.6	8.4	7.9	
144	11.3	11.3	-	9.3	8.2	7.9	
152	5.9	-	-	8.8	8.2	7.9	
160	-	-	-	8.5	8.2	4.7	
168	-	-	-	8.0	7.8	-	
176	-	-	-	7.6	7.0	-	

 202.1 ft							
  37.4 ft							
  68.9 ft							
ft	0°	20°	40°	0°	20°	40°	1,000 lb
48	13.2	-	-	-	-	-	
56	13.2	-	-	7.7	-	-	
64	13.2	-	-	7.7	-	-	
72	13.2	-	-	7.7	-	-	
80	13.2	13.2	-	7.7	-	-	
88	13.2	13.2	13.2	7.7	-	-	
96	13.2	13.2	13.2	7.7	7.7	-	
104	13.2	13.2	13.2	7.7	7.7	-	
112	12.7	12.7	12.5	7.7	7.7	7.5	
120	11.9	11.9	11.9	7.7	7.7	7.5	
128	11.1	11.1	11.1	7.7	7.7	7.5	
136	10.3	10.3	10.3	7.7	7.7	7.5	
144	9.1	9.5	9.7	7.5	7.5	7.5	
152	7.8	8.6	8.7	7.2	7.2	7.2	
160	6.5	7.3	7.7	6.6	6.9	6.7	
168	5.8	6.1	6.5	5.5	6.3	6.5	
176	5.0	5.4	5.4	4.7	5.6	6.2	
184	4.2	4.6	4.7	4.1	4.7	5.5	
192	3.4	3.8	4.0	3.4	4.0	4.6	
200	2.5	3.0	3.0	2.5	3.4	3.7	
208	-	-	-	-	-	3.1	
216	-	-	-	-	-	2.5	

 223.1 ft							
  37.4 ft							
  68.9 ft							
ft	0°	20°	40°	0°	20°	40°	1,000 lb
56	9.5	-	-	-	-	-	
64	9.5	-	-	-	-	-	
72	9.5	-	-	5.7	-	-	
80	9.5	9.5	-	5.7	-	-	
88	9.5	9.5	-	5.7	-	-	
96	9.5	9.5	9.5	5.7	-	-	
104	9.5	9.5	9.5	5.7	-	-	
112	9.5	9.5	9.5	5.7	-	-	
120	9.5	9.5	9.5	5.7	-	-	
128	9.4	9.5	9.5	5.7	-	-	
136	8.8	9.2	9.2	5.7	-	-	
144	8.2	8.4	8.4	5.7	-	-	
152	7.3	7.6	7.8	5.7	-	-	
160	6.1	6.8	7.0	5.5	-	-	
168	5.0	5.9	6.1	4.6	-	-	
176	3.9	4.8	5.0	3.7	-	-	
184	3.1	3.7	4.0	3.0	-	-	

71,900 lb		26.70 ft x 24.60 ft		360°		85%						
40.7 ft												
37.4 ft				68.9 ft								
0°		20°		40°		0°		20°		40°		
ft	1,000 lb			1,000 lb			1,000 lb			1,000 lb		
10	41.2	-	-	22.2	-	-	39.0	-	-	-	-	
12	41.2	-	-	22.0	-	-	38.6	-	-	16.6	-	
14	41.2	-	-	21.9	-	-	38.2	-	-	16.4	-	
16	41.2	-	-	21.7	-	-	37.7	-	-	16.1	-	
18	41.2	34.8	-	21.4	-	-	37.2	29.2	-	15.9	-	
20	41.2	31.9	-	21.1	-	-	35.6	27.3	21.4	15.5	-	
24	41.2	29.5	-	20.5	-	-	33.0	25.5	20.6	15.1	12.8	
28	39.6	27.5	-	19.7	-	-	30.1	23.9	20.0	14.7	12.1	
32	35.8	25.8	22.5	18.9	-	-	27.4	22.5	19.4	14.1	11.5	
36	32.7	24.3	21.5	17.9	-	-	24.7	21.2	18.9	13.8	10.9	
40	29.9	21.7	20.6	16.8	13.6	-	21.4	20.1	18.3	13.3	10.4	
48	25.7	19.9	19.3	14.9	12.3	-	18.2	18.8	17.8	12.7	9.9	
56	22.3	18.7	18.6	13.2	11.2	9.7	15.8	16.5	16.9	12.0	9.5	
64	19.8	-	-	11.7	10.3	9.1	14.0	14.4	15.1	11.2	9.2	
72	-	-	-	10.6	9.5	8.6	12.6	12.7	12.7	10.6	9.0	
80	-	-	-	9.8	9.0	8.3	11.0	11.6	7.6	10.0	8.7	
88	-	-	-	9.1	8.5	8.2	9.6	9.8	-	9.0	8.4	
96	-	-	-	8.5	8.2	-	9.1	8.8	-	8.2	8.2	
							152	5.9	-	7.6	7.5	
							160	-	-	6.5	6.9	
							168	-	-	5.9	4.3	
							176	-	-	5.6	3.8	

202.1 ft												
37.4 ft				68.9 ft								
0°		20°		40°		0°		20°		40°		
ft	1,000 lb			1,000 lb			1,000 lb			1,000 lb		
48	13.2	-	-	-	-	-	9.5	-	-	-	-	
56	13.2	-	-	7.7	-	-	9.5	-	-	-	-	
64	13.2	-	-	7.7	-	-	9.5	-	-	5.7	-	
72	13.2	-	-	7.7	-	-	9.5	9.5	-	5.7	-	
80	13.2	13.2	-	7.7	-	-	9.5	9.5	-	5.7	-	
88	13.2	13.2	13.2	7.7	-	-	9.5	9.5	9.5	5.7	-	
96	13.2	13.2	13.2	7.7	7.7	-	9.5	9.5	9.5	5.7	-	
104	12.5	13.2	13.2	7.7	7.7	-	9.4	9.5	9.5	5.7	-	
112	11.1	12.0	12.5	7.7	7.7	7.5	7.6	9.1	9.4	5.7	-	
120	9.3	10.3	11.2	7.5	7.7	7.5	6.1	7.5	8.6	5.2	-	
128	7.7	9.0	9.6	6.5	7.7	7.5	4.7	6.0	7.1	3.8	-	
136	6.4	7.6	8.3	5.5	7.1	7.5	3.6	4.7	5.8	2.7	-	
144	5.1	6.0	6.9	4.5	6.2	7.5	-	3.6	4.5	-	-	
152	4.0	4.9	5.6	3.4	5.1	6.5	-	2.6	3.4	-	-	
160	3.0	3.9	4.3	-	4.2	5.6						
168	-	-	-	-	3.3	4.5						
176	-	-	-	-	2.3	3.5						

223.1 ft												
37.4 ft				68.9 ft								
0°		20°		40°		0°		20°		40°		
ft	1,000 lb			1,000 lb			1,000 lb			1,000 lb		
56	9.5	-	-	-	-	-	9.5	-	-	-	-	
64	9.5	-	-	-	-	-	9.5	-	-	-	-	
72	9.5	-	-	-	-	-	9.5	-	-	5.7	-	
80	9.5	9.5	-	-	-	-	9.5	9.5	-	5.7	-	
88	9.5	9.5	-	-	-	-	9.5	9.5	-	5.7	-	
96	9.5	9.5	9.5	5.7	-	-	9.5	9.5	9.5	5.7	-	
104	9.5	9.5	9.5	5.7	-	-	9.4	9.5	9.5	5.7	-	
112	9.4	9.5	9.5	5.7	-	-	7.6	9.1	9.4	5.7	-	
120	7.6	9.1	9.4	5.7	-	-	6.1	7.5	8.6	5.2	-	
128	6.1	7.5	8.6	5.2	-	-	4.7	6.0	7.1	3.8	-	
136	4.7	6.0	7.1	3.8	-	-	3.6	4.7	5.8	2.7	-	
144	3.6	4.7	5.8	2.7	-	-	-	3.6	4.5	-	-	
152	-	3.6	4.5	-	-	-	-	2.6	3.4	-	-	
160	-	2.6	3.4	-	-	-						

56,000 lb								26.70 ft x 24.60 ft				360°			85%			
40.7 ft												121.4 ft						
ft	37.4 ft			68.9 ft			ft	37.4 ft			68.9 ft			ft	37.4 ft		68.9 ft	
	0°	20°	40°	0°	20°	40°		0°	20°	40°	0°	20°	40°		0°	20°	40°	
1,000 lb																		
10	41.2	-	-	22.2	-	-	24	39.0	-	-	-	-	-	-	-	-		
12	41.2	-	-	22.0	-	-	28	38.6	-	-	16.6	-	-	-	-	-		
14	41.2	-	-	21.9	-	-	32	38.2	-	-	16.4	-	-	-	-	-		
16	41.2	-	-	21.7	-	-	36	37.7	-	-	16.1	-	-	-	-	-		
18	41.2	-	-	21.4	-	-	40	37.2	29.2	-	15.9	-	-	-	-	-		
20	41.2	34.8	-	21.1	-	-	48	35.6	27.3	21.4	15.5	-	-	-	-	-		
24	41.2	31.9	-	20.5	-	-	56	33.0	25.5	20.6	15.1	12.8	-	-	-	-		
28	39.6	29.5	-	19.7	-	-	64	29.8	23.9	20.0	14.7	12.1	-	-	-	-		
32	35.8	27.5	22.5	18.9	-	-	72	25.2	22.5	19.4	14.1	11.5	-	-	-	-		
36	32.7	25.8	21.5	17.9	-	-	80	21.5	21.0	18.9	13.8	10.9	9.0	-	-	-		
40	29.9	24.3	20.6	16.8	13.6	-	88	17.9	18.9	18.2	13.3	10.4	8.7	-	-	-		
48	25.7	21.7	19.3	14.9	12.3	-	96	15.8	16.1	16.8	12.7	9.9	8.5	-	-	-		
56	22.3	19.9	18.6	13.2	11.2	9.7	104	13.5	14.0	14.3	12.0	9.5	8.4	-	-	-		
64	19.8	18.7	-	11.7	10.3	9.1	112	12.0	12.2	12.7	11.1	9.2	8.2	-	-	-		
72	-	-	-	10.6	9.5	8.6	120	10.6	10.7	10.8	10.0	9.0	8.1	-	-	-		
80	-	-	-	9.8	9.0	8.3	128	9.6	9.7	7.6	8.7	8.6	7.9	-	-	-		
88	-	-	-	9.1	8.5	8.2	136	8.2	8.5	-	7.9	8.2	7.9	-	-	-		
96	-	-	-	8.5	8.2	-	144	7.3	7.3	-	6.9	7.3	7.5	-	-	-		
							152	5.9	-	-	6.3	6.7	6.9	-	-	-		
							160	-	-	-	5.5	5.8	4.7	-	-	-		
							168	-	-	-	4.8	4.2	-	-	-	-		
							176	-	-	-	4.3	3.8	-	-	-	-		

202.1 ft														
ft	37.4 ft			68.9 ft			ft	37.4 ft			68.9 ft			
	0°	20°	40°	0°	20°	40°		0°	20°	40°	0°	20°	40°	
1,000 lb														
48	13.2	-	-	-	-	-	56	9.5	-	-	-	-	-	
56	13.2	-	-	7.7	-	-	64	9.5	-	-	-	-	-	
64	13.2	-	-	7.7	-	-	72	9.5	-	-	5.7	-	-	
72	13.2	-	-	7.7	-	-	80	9.5	9.5	-	5.7	-	-	
80	13.2	13.2	-	7.7	-	-	88	9.5	9.5	-	5.7	-	-	
88	12.8	13.2	13.2	7.7	-	-	96	9.2	9.5	9.5	5.7	-	-	
96	11.0	12.5	13.2	7.7	7.7	-	104	7.5	9.1	9.5	5.7	-	-	
104	9.3	10.9	11.9	7.5	7.7	-	112	5.9	7.4	8.9	4.8	-	-	
112	7.6	9.2	10.3	6.5	7.7	7.5	120	4.3	5.8	7.1	3.2	-	-	
120	6.0	7.3	8.4	5.0	7.1	7.5	128	3.0	4.3	5.5	-	-	-	
128	4.6	5.8	6.9	3.7	6.1	7.4	136	-	3.1	4.2	-	-	-	
136	3.5	4.7	5.6	2.7	4.7	6.5	144	-	-	2.9	-	-	-	
144	2.5	3.6	4.2	-	3.6	5.4								
152	-	-	3.2	-	-	4.3								
160	-	-	-	-	-	3.2								

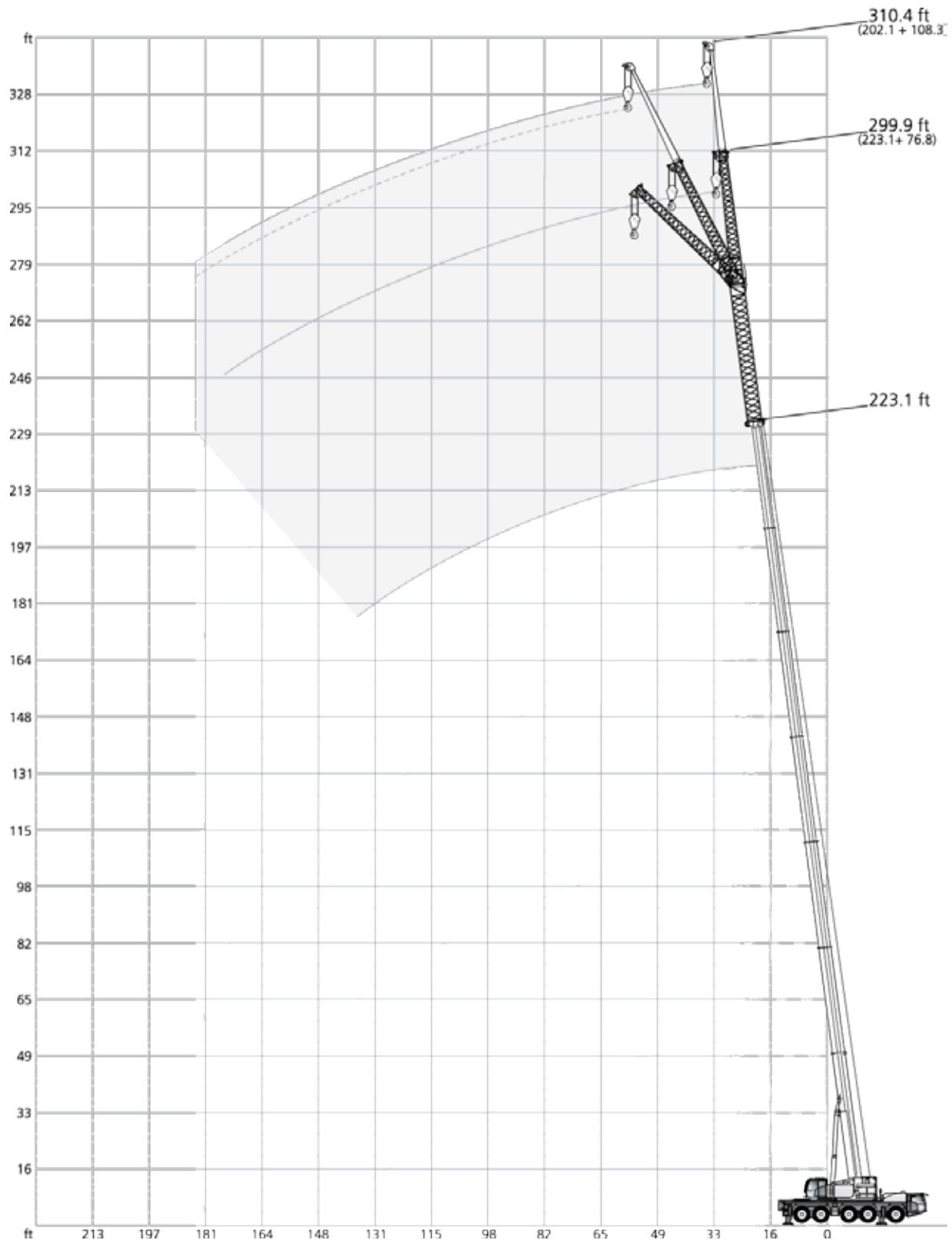
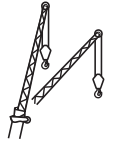

223.1 ft														
ft	37.4 ft			68.9 ft			ft	37.4 ft			68.9 ft			
	0°	20°	40°	0°	20°	40°		0°	20°	40°	0°	20°	40°	
1,000 lb														
56	9.5	-	-	-	-	-	64	9.5	-	-	-	-	-	
64	9.5	-	-	-	-	-	72	9.5	-	-	5.7	-	-	
72	9.5	-	-	-	-	-	80	9.5	9.5	-	5.7	-	-	
80	9.5	9.5	-	5.7	-	-	88	9.5	9.5	-	5.7	-	-	
88	9.5	9.5	-	5.7	-	-	96	9.2	9.5	9.5	5.7	-	-	
96	9.2	9.5	9.5	5.7	-	-	104	7.5	9.1	9.5	5.7	-	-	
104	7.5	9.1	9.5	5.7	-	-	112	5.9	7.4	8.9	4.8	-	-	
112	5.9	7.4	8.9	4.8	-	-	120	4.3	5.8	7.1	3.2	-	-	
120	4.3	5.8	7.1	3.2	-	-	128	3.0	4.3	5.5	-	-	-	
128	3.0	4.3	5.5	-	-	-	136	-	3.1	4.2	-	-	-	
136	-	3.1	4.2	-	-	-	144	-	-	2.9	-	-	-	
144	-	-	2.9	-	-	-								





101,400 lb							26.70 ft x 24.60 ft			360°			85%		
40.7 ft										121.4 ft					
ft	76.8 ft			108.3 ft			ft	76.8 ft			108.3 ft				
	0°	20°	40°	0°	20°	40°		0°	20°	40°	0°	20°	40°		
1,000 lb															
16	38.0	-	-	-	-	-	36	21.4	-	-	-	-	-		
18	36.5	-	-	-	-	-	40	21.1	-	-	11.9	-	-		
20	35.0	-	-	-	17.2	-	48	20.8	-	-	11.8	-	-		
24	32.0	-	-	-	16.8	-	56	19.9	17.7	-	11.6	-	-		
28	28.8	-	-	-	16.4	-	64	18.7	16.4	14.5	11.3	-	-		
32	25.9	22.4	-	-	16.1	-	72	17.4	15.0	13.7	11.0	10.2	-		
36	23.6	20.7	-	-	15.9	-	80	16.1	14.0	12.9	10.7	9.6	-		
40	21.5	19.0	17.5	-	15.5	-	88	14.8	13.2	12.2	10.1	8.9	-		
48	18.0	16.6	15.4	14.1	13.0	-	96	13.8	12.4	11.5	9.4	8.3	-		
56	15.6	14.4	13.7	12.5	11.5	-	104	12.9	11.6	10.9	8.9	7.8	-		
64	13.6	12.8	12.4	11.1	10.2	-	112	12.1	11.0	10.3	8.3	7.3	-		
72	12.2	11.5	11.1	9.9	9.1	-	120	11.3	10.5	10.0	7.9	6.9	-		
80	10.9	10.4	10.2	8.9	8.3	-	128	10.6	9.9	9.6	7.5	6.5	-		
88	9.8	9.4	9.4	7.9	7.4	-	136	10.0	9.4	9.2	7.0	6.2	-		
96	8.8	8.8	-	7.1	6.6	-	144	9.5	9.1	8.8	6.6	5.8	-		
104	8.2	8.2	-	6.5	6.0	-	152	9.0	8.6	8.5	6.1	5.5	-		
112	-	-	-	5.7	5.5	-	160	8.3	8.3	5.6	5.8	5.2	-		
120	-	-	-	5.2	5.2	-	168	7.4	7.6	-	5.4	5.0	-		
128	-	-	-	5.0	4.7	-	176	6.7	6.9	-	5.1	4.9	-		
136	-	-	-	4.5	-	-	184	2.6	2.7	-	4.8	4.6	-		
							192	-	-	-	4.6	4.4	-		
							200	-	-	-	4.3	4.2	-		
							208	-	-	-	4.0	-	-		
							216	-	-	-	3.6	-	-		







202.1 ft						
ft	76.8 ft			108.3 ft		
	0°	20°	40°	0°	20°	40°
1,000 lb						
64	7.5	-	-	-	-	-
72	7.5	-	-	3.7	-	-
80	7.5	7.3	-	3.7	-	-
88	7.5	7.3	6.4	3.7	-	-
96	7.5	7.3	6.3	3.7	-	-
104	7.5	7.3	6.2	3.7	3.7	-
112	7.5	7.3	6.0	3.7	3.7	-
120	7.5	7.3	6.0	3.7	3.7	-
128	7.5	7.3	5.8	3.7	3.7	-
136	7.3	7.3	5.7	3.7	3.7	-
144	6.9	6.9	5.7	3.7	3.7	-
152	6.5	6.5	5.5	3.7	3.7	-
160	5.9	6.1	5.5	3.7	3.7	-
168	5.0	5.6	5.4	3.6	3.7	-
176	4.1	4.7	5.3	3.3	3.7	-
184	3.5	3.8	4.4	-	3.5	-
192	-	3.2	3.4	-	-	-
200	-	2.7	2.9	-	-	-



223.1 ft			
ft	76.8 ft		
	0°	20°	40°
1,000 lb			
72	4.9	-	-
80	4.9	-	-
88	4.9	-	-
96	4.9	-	-
104	4.9	-	-
112	4.9	-	-
120	4.9	-	-
128	4.9	-	-
136	4.9	-	-
144	4.9	-	-
152	4.9	-	-
160	4.8	-	-
168	4.2	-	-
176	3.2	-	-



71,900 lb  26.70 ft x 24.60 ft										360°				85%															
40.7 ft 										121.4 ft 																			
76.8 ft					108.3 ft					76.8 ft					108.3 ft														
ft		0°			20°			40°			0°		20°			40°			ft		0°			20°			40°		
										1,000 lb										1,000 lb									
16		38.0	-	-	-	-	-	-	-	36	21.4	-	-	-	-	-	-	-	40	21.1	-	-	11.9	-	-				
18		36.5	-	-	-	-	-	-	-	48	20.8	-	-	-	11.8	-	-	-	56	19.9	17.7	-	11.6	-	-				
20		35.0	-	-	-	17.2	-	-	-	64	18.7	16.4	14.5	11.3	-	-	-	72	17.4	15.0	13.7	11.0	10.2	-					
24		32.0	-	-	-	16.8	-	-	-	80	16.1	14.0	12.9	10.7	9.6	-	-	88	14.8	13.2	12.2	10.1	8.9	-					
28		28.8	-	-	-	16.4	-	-	-	96	13.8	12.4	11.5	9.4	8.3	-	-	104	12.9	11.6	10.9	8.9	7.8	-					
32		25.9	22.4	-	-	16.1	-	-	-	112	12.1	11.0	10.3	8.3	7.3	-	-	120	11.2	10.5	10.0	7.9	6.9	-					
36		23.6	20.7	-	-	15.9	-	-	-	128	10.2	9.8	9.6	7.5	6.5	-	-	136	8.7	9.2	9.1	7.0	6.2	-					
40		21.5	19.0	17.5	-	15.5	-	-	-	144	7.3	8.0	8.4	6.6	5.8	-	-	152	6.6	6.9	7.1	6.1	5.5	-					
48		18.0	16.6	15.4	14.1	13.0	-	-	-	160	6.1	6.1	5.6	5.4	5.2	-	-	168	5.1	5.5	-	4.8	4.9	-					
56		15.6	14.4	13.7	12.5	11.5	-	-	-	176	4.7	4.7	-	4.3	4.5	-	-	184	2.6	2.7	-	3.5	4.0	-					
64		13.6	12.8	12.4	11.1	10.2	-	-	-	192	-	-	-	3.0	3.4	-	-	200	-	-	-	2.6	3.0	-					
72		12.2	11.5	11.1	9.9	9.1	-	-	-																				
80		10.9	10.4	10.2	8.9	8.3	-	-	-																				
88		9.8	9.4	9.4	7.9	7.4	-	-	-																				
96		8.8	8.8	-	7.1	6.6	-	-	-																				
104		8.2	8.2	-	6.5	6.0	-	-	-																				
112		-	-	-	5.7	5.5	-	-	-																				
120		-	-	-	5.2	5.2	-	-	-																				
128		-	-	-	5.0	4.7	-	-	-																				
136		-	-	-	4.5	-	-	-	-																				

202.1 ft 										
76.8 ft					108.3 ft					
ft		0°			20°			40°		
1,000 lb										
64		7.5	-	-	-	-	-	-	-	
72		7.5	-	-	-	3.7	-	-	-	
80		7.5	7.3	-	-	3.7	-	-	-	
88		7.5	7.3	6.4	-	3.7	-	-	-	
96		7.5	7.3	6.3	-	3.7	-	-	-	
104		7.5	7.3	6.2	-	3.7	3.7	-	-	
112		7.5	7.3	6.0	-	3.7	3.7	-	-	
120		7.2	7.3	6.0	-	3.7	3.7	-	-	
128		6.1	6.9	5.8	-	3.7	3.7	-	-	
136		4.9	6.0	5.7	-	3.3	3.7	-	-	
144		3.8	4.9	5.5	-	2.3	3.7	-	-	
152		2.8	3.9	4.7	-	-	3.4	-	-	
160		-	3.0	3.7	-	-	-	-	-	

223.1 ft 										
76.8 ft										
ft		0°			20°			40°		
1,000 lb										
72		4.9	-	-	-	-	-	-	-	
80		4.9	-	-	-	-	-	-	-	
88		4.9	-	-	-	-	-	-	-	
96		4.9	-	-	-	-	-	-	-	
104		4.9	-	-	-	-	-	-	-	
112		4.9	-	-	-	-	-	-	-	
120		4.9	-	-	-	-	-	-	-	
128		4.4	-	-	-	-	-	-	-	
136		3.3	-	-	-	-	-	-	-	

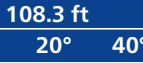
56,000 lb										26.70 ft x 24.60 ft										360°										85%									
 40.7 ft																				 121.4 ft																			
 76.8 ft										 108.3 ft										 76.8 ft										 108.3 ft									
ft		0°		20°		40°		0°		20°		40°		0°		20°		40°		ft		0°		20°		40°		0°		20°		40°							
1,000 lb																																							
16		38.0	-	-	-	-	-	-	-	-	-	-	-	-	-	-	-	-	-	36	21.4	-	-	-	-	-	-	-	-	-	-	-							
18		36.5	-	-	-	-	-	-	-	-	-	-	-	-	-	-	-	-	-	40	21.1	-	-	11.9	-	-	-	-	-	-	-	-							
20		35.0	-	-	-	-	-	17.2	-	-	-	-	-	-	-	-	-	-	-	48	20.8	-	-	11.8	-	-	-	-	-	-	-	-							
24		32.0	-	-	-	-	-	16.8	-	-	-	-	-	-	-	-	-	-	-	56	19.9	17.7	-	11.6	-	-	-	-	-	-	-	-							
28		28.8	-	-	-	-	-	16.4	-	-	-	-	-	-	-	-	-	-	-	64	18.7	16.4	14.5	11.3	-	-	-	-	-	-	-	-							
32		25.9	22.4	-	-	-	-	16.1	-	-	-	-	-	-	-	-	-	-	-	72	17.4	15.0	13.7	11.0	10.2	-	-	-	-	-	-	-							
36		23.6	20.7	-	-	-	-	15.9	-	-	-	-	-	-	-	-	-	-	-	80	16.1	14.0	12.9	10.7	9.6	-	-	-	-	-	-	-							
40		21.5	19.0	17.5	-	-	-	15.5	-	-	-	-	-	-	-	-	-	-	-	88	14.8	13.2	12.2	10.1	8.9	-	-	-	-	-	-	-							
48		18.0	16.6	15.4	14.1	13.0	-	14.1	13.0	-	-	-	-	-	-	-	-	-	-	96	13.8	12.4	11.5	9.4	8.3	-	-	-	-	-	-	-							
56		15.6	14.4	13.7	12.5	11.5	-	12.5	11.5	-	-	-	-	-	-	-	-	-	-	104	12.7	11.6	10.9	8.9	7.8	-	-	-	-	-	-	-							
64		13.6	12.8	12.4	11.1	10.2	-	11.1	10.2	-	-	-	-	-	-	-	-	-	-	112	10.9	10.9	10.3	8.3	7.3	-	-	-	-	-	-	-							
72		12.2	11.5	11.1	9.9	9.1	-	9.9	9.1	-	-	-	-	-	-	-	-	-	-	120	9.6	10.0	9.9	7.8	6.9	-	-	-	-	-	-	-							
80		10.9	10.4	10.2	8.9	8.3	-	8.9	8.3	-	-	-	-	-	-	-	-	-	-	128	8.3	8.9	9.0	7.3	6.5	-	-	-	-	-	-	-							
88		9.8	9.4	9.4	7.9	7.4	-	7.9	7.4	-	-	-	-	-	-	-	-	-	-	136	7.2	7.6	8.0	6.7	6.2	-	-	-	-	-	-	-							
96		8.8	8.8	-	7.1	6.6	-	7.1	6.6	-	-	-	-	-	-	-	-	-	-	144	6.4	6.6	6.8	5.8	5.8	-	-	-	-	-	-	-							
104		8.2	8.2	-	6.5	6.0	-	6.5	6.0	-	-	-	-	-	-	-	-	-	-	152	5.5	5.8	6.0	5.0	5.5	-	-	-	-	-	-	-							
112		-	-	-	5.7	5.5	-	5.7	5.5	-	-	-	-	-	-	-	-	-	-	160	5.0	5.1	5.0	4.4	5.0	-	-	-	-	-	-	-							
120		-	-	-	5.2	5.2	-	5.2	5.2	-	-	-	-	-	-	-	-	-	-	168	4.2	4.5	-	3.6	4.1	-	-	-	-	-	-	-							
128		-	-	-	5.0	4.7	-	5.0	4.7	-	-	-	-	-	-	-	-	-	-	176	3.8	3.8	-	3.1	3.6	-	-	-	-	-	-	-							
136		-	-	-	4.5	-	-	4.5	-	-	-	-	-	-	-	-	-	-	-	184	2.6	2.7	-	2.6	3.0	-	-	-	-	-	-	-							

 202.1 ft																					
 76.8 ft										 108.3 ft											
ft		0°		20°		40°		0°		20°		40°		ft		0°		20°		40°	
1,000 lb																					
64		7.5	-	-	-	-	-	-	-	-	-	-	-	-	72	4.9	-	-	-	-	-
72		7.5	-	-	-	-	-	3.7	-	-	-	-	-	80	4.9	-	-	-	-	-	-
80		7.5	7.3	-	-	-	-	3.7	-	-	-	-	-	88	4.9	-	-	-	-	-	-
88		7.5	7.3	6.4	-	-	-	3.7	-	-	-	-	-	96	4.9	-	-	-	-	-	-
96		7.5	7.3	6.3	3.7	-	-	3.7	-	-	-	-	-	104	4.9	-	-	-	-	-	-
104		7.1	7.3	6.2	3.7	3.7	-	3.7	3.7	-	-	-	-	112	4.1	-	-	-	-	-	-
112		5.9	7.2	6.0	3.7	3.7	-	3.7	3.7	-	-	-	-								
120		4.5	5.9	6.0	-	3.7	-	-	3.7	-	-	-	-								
128		3.2	4.5	5.4	-	3.6	-	-	3.6	-	-	-	-								
136		-	3.3	4.4	-	2.9	-	-	2.9	-	-	-	-								
144		-	2.3	3.1	-	-	-	-	-	-	-	-	-								

 223.1 ft															
 76.8 ft															
ft		0°		20°		40°		ft		0°		20°		40°	
1,000 lb															
72		4.9	-	-	-	-	-	-	72	4.9	-	-	-	-	
80		4.9	-	-	-	-	-	-	80	4.9	-	-	-	-	
88		4.9	-	-	-	-	-	-	88	4.9	-	-	-	-	
96		4.9	-	-	-	-	-	-	96	4.9	-	-	-	-	
104		4.9	-	-	-	-	-	-	104	4.9	-	-	-	-	
112		4.1	-	-	-	-	-	-	112	4.1	-	-	-	-	

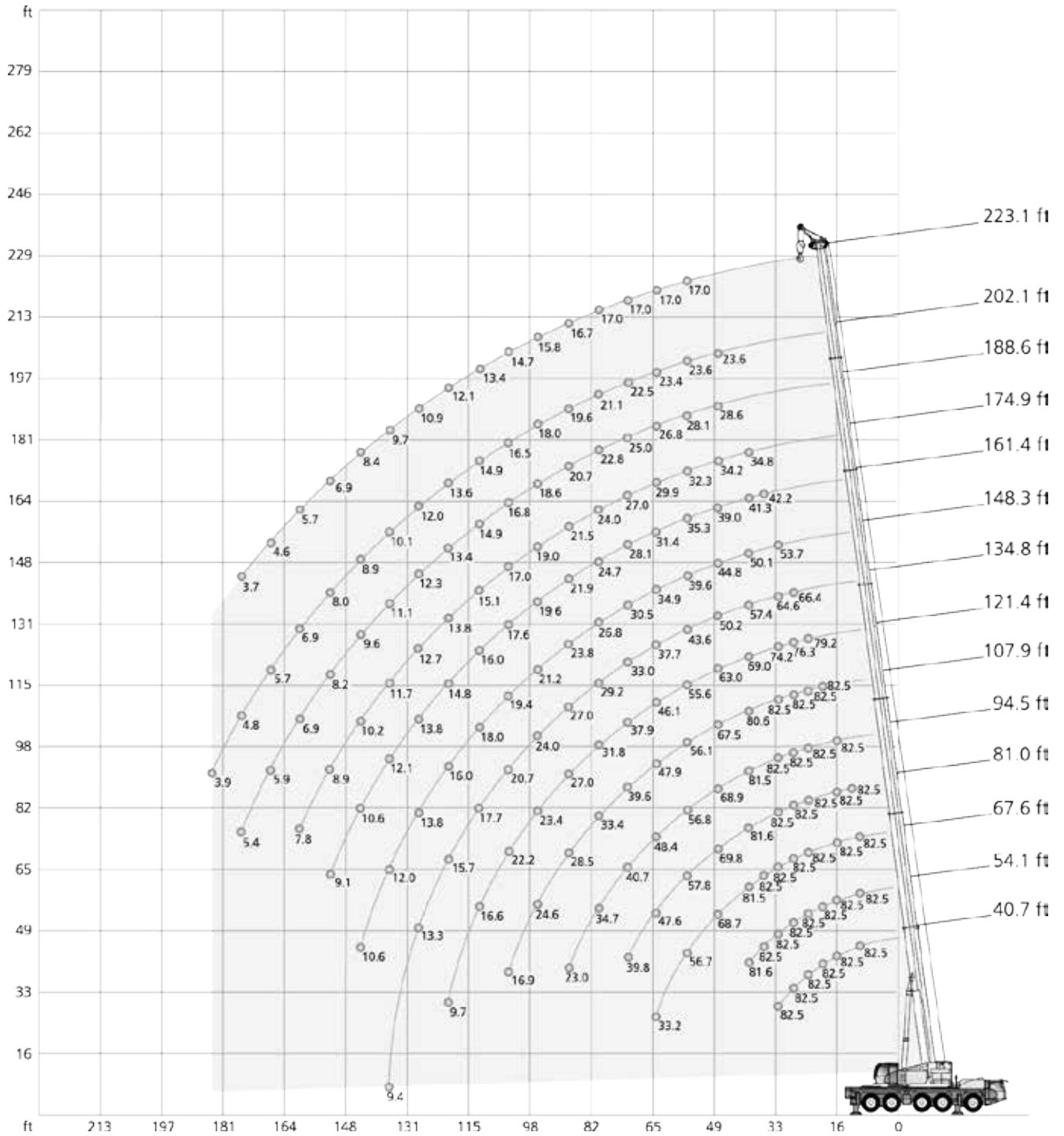
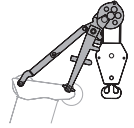

☰ 101,400 lb		📏 26.70 ft x 24.60 ft														360°		85%	
📐		(ft)														📐			
ft		40.7	54.1	67.6	81.0	94.5	107.9	121.4	134.8	148.3	161.4	174.9	188.6	202.1	223.1	ft			
		1,000 lb																	
10		82.5	82.5	82.5	-	-	-	-	-	-	-	-	-	-	-	-	10		
12		82.5	82.5	82.5	82.5	-	-	-	-	-	-	-	-	-	-	-	12		
14		82.5	82.5	82.5	82.5	-	-	-	-	-	-	-	-	-	-	-	14		
16		82.5	82.5	82.5	82.5	82.5	-	-	-	-	-	-	-	-	-	-	16		
18		82.5	82.5	82.5	82.5	82.5	-	-	-	-	-	-	-	-	-	-	18		
20		82.5	82.5	82.5	82.5	82.5	82.5	-	-	-	-	-	-	-	-	-	20		
24		82.5	82.5	82.5	82.5	82.5	82.5	79.2	-	-	-	-	-	-	-	-	24		
28		82.5	82.5	82.5	82.5	82.5	82.5	76.3	66.4	-	-	-	-	-	-	-	28		
32		82.5	82.5	82.5	82.5	82.5	82.5	74.2	64.6	53.7	-	-	-	-	-	-	32		
36		-	82.5	82.5	82.5	82.5	82.0	71.7	61.2	52.1	42.2	-	-	-	-	-	36		
40		-	81.6	81.5	81.6	81.5	80.6	69.0	57.4	50.1	41.3	34.8	-	-	-	-	40		
48		-	-	68.7	69.8	68.9	67.5	63.0	50.2	44.8	39.0	34.2	28.6	23.6	-	-	48		
56		-	-	56.7	57.8	56.8	56.1	55.6	43.6	39.6	35.3	32.3	28.1	23.6	17.0	-	56		
64		-	-	33.2	47.6	48.4	47.9	46.1	37.7	34.9	31.4	29.9	26.8	23.4	17.0	-	64		
72		-	-	-	39.8	40.7	39.6	37.9	33.0	30.5	28.1	27.0	25.0	22.5	17.0	-	72		
80		-	-	-	-	34.7	33.4	31.8	29.2	26.8	24.7	24.0	22.8	21.1	17.0	-	80		
88		-	-	-	-	23.0	28.5	27.0	27.0	23.8	21.9	21.5	20.7	19.6	16.7	-	88		
96		-	-	-	-	-	24.6	23.4	24.0	21.2	19.6	19.0	18.6	18.0	15.8	-	96		
104		-	-	-	-	-	16.9	22.2	20.7	19.4	17.6	17.0	16.8	16.5	14.7	-	104		
112		-	-	-	-	-	-	16.6	17.7	18.0	16.0	15.1	14.9	14.9	13.4	-	112		
120		-	-	-	-	-	-	9.7	15.7	16.0	14.8	13.8	13.4	13.6	12.1	-	120		
128		-	-	-	-	-	-	-	13.3	13.8	13.8	12.7	12.3	12.0	10.9	-	128		
136		-	-	-	-	-	-	-	9.4	12.0	12.1	11.7	11.1	10.1	9.7	-	136		
144		-	-	-	-	-	-	-	-	10.6	10.6	10.2	9.6	8.9	8.4	-	144		
152		-	-	-	-	-	-	-	-	-	9.1	8.9	8.2	8.0	6.9	-	152		
160		-	-	-	-	-	-	-	-	-	-	7.8	6.9	6.9	5.7	-	160		
168		-	-	-	-	-	-	-	-	-	-	-	5.9	5.7	4.6	-	168		
176		-	-	-	-	-	-	-	-	-	-	-	5.4	4.8	3.7	-	176		
184		-	-	-	-	-	-	-	-	-	-	-	-	3.9	-	-	184		
1)		39.0	29.1	22.9	18.1	14.6	11.5	9.0	6.8	4.9	3.7	-	-	-	-	-	1)		

1) Capacities with horizontal boom

		71,900 lb				26.70 ft x 24.60 ft				360°				85%				
		(ft)																
		1,000 lb																
		ft																
		ft																
10		82.5	82.5	82.5	-	-	-	-	-	-	-	-	-	-	-	-	-	10
12		82.5	82.5	82.5	82.5	-	-	-	-	-	-	-	-	-	-	-	-	12
14		82.5	82.5	82.5	82.5	-	-	-	-	-	-	-	-	-	-	-	-	14
16		82.5	82.5	82.5	82.5	82.5	-	-	-	-	-	-	-	-	-	-	-	16
18		82.5	82.5	82.5	82.5	82.5	-	-	-	-	-	-	-	-	-	-	-	18
20		82.5	82.5	82.5	82.5	82.5	82.5	-	-	-	-	-	-	-	-	-	-	20
24		82.5	82.5	82.5	82.5	82.5	82.5	79.2	-	-	-	-	-	-	-	-	-	24
28		82.5	82.5	82.5	82.5	82.5	82.5	76.3	66.4	-	-	-	-	-	-	-	-	28
32		82.5	82.5	82.5	82.5	82.5	82.5	74.2	64.6	53.7	-	-	-	-	-	-	-	32
36		-	81.5	81.0	81.5	81.1	79.3	71.7	61.2	52.1	42.2	-	-	-	-	-	-	36
40		-	78.7	77.6	78.8	77.8	74.5	68.6	57.4	50.1	41.3	34.8	-	-	-	-	-	40
48		-	-	59.2	58.7	57.4	58.7	57.0	50.2	44.8	39.0	34.2	28.6	23.6	-	-	-	48
56		-	-	45.9	47.3	47.1	45.9	43.9	42.2	39.6	35.3	32.3	28.1	23.6	17.0	-	-	56
64		-	-	30.1	38.5	37.8	36.7	34.7	34.4	33.0	31.4	29.9	26.8	23.4	17.0	-	-	64
72		-	-	-	31.7	31.0	29.9	29.6	29.2	27.3	27.0	26.5	25.0	22.5	17.0	-	-	72
80		-	-	-	-	26.0	25.2	25.8	24.2	24.0	22.6	22.6	22.3	21.1	17.0	-	-	80
88		-	-	-	-	16.0	22.8	22.0	21.0	20.8	20.0	19.4	19.2	18.9	16.7	-	-	88
96		-	-	-	-	-	19.9	18.6	18.8	17.3	17.5	17.0	16.4	15.7	14.8	-	-	96
104		-	-	-	-	-	13.8	16.3	16.2	15.8	14.9	14.8	13.6	13.5	12.2	-	-	104
112		-	-	-	-	-	-	10.5	14.0	14.0	13.3	12.7	12.0	11.3	10.0	-	-	112
120		-	-	-	-	-	-	9.7	12.5	11.9	11.5	11.0	10.6	9.3	8.2	-	-	120
128		-	-	-	-	-	-	-	10.0	10.4	9.7	9.8	8.8	7.5	6.4	-	-	128
136		-	-	-	-	-	-	-	9.4	9.3	8.3	8.3	7.4	6.0	4.9	-	-	136
144		-	-	-	-	-	-	-	-	5.8	7.5	7.1	6.0	4.7	3.6	-	-	144
152		-	-	-	-	-	-	-	-	-	4.7	5.8	4.9	3.6	-	-	-	152
160		-	-	-	-	-	-	-	-	-	-	5.0	3.9	-	-	-	-	160
1)		39.0	29.1	22.9	18.1	14.6	11.5	9.0	6.8	4.9	3.7	-	-	-	-	-	-	1)

1) Capacities with horizontal boom

56,000 lb		26.70 ft x 24.60 ft														360°		85%	
		(ft)																	
		40.7	54.1	67.6	81.0	94.5	107.9	121.4	134.8	148.3	161.4	174.9	188.6	202.1	223.1				
ft		1,000 lb														ft			
10		82.5	82.5	82.5	-	-	-	-	-	-	-	-	-	-	-	-	10		
12		82.5	82.5	82.5	82.5	-	-	-	-	-	-	-	-	-	-	-	12		
14		82.5	82.5	82.5	82.5	-	-	-	-	-	-	-	-	-	-	-	14		
16		82.5	82.5	82.5	82.5	82.5	-	-	-	-	-	-	-	-	-	-	16		
18		82.5	82.5	82.5	82.5	82.5	82.5	-	-	-	-	-	-	-	-	-	18		
20		82.5	82.5	82.5	82.5	82.5	82.5	-	-	-	-	-	-	-	-	-	20		
24		82.5	82.5	82.5	82.5	82.5	82.5	79.2	-	-	-	-	-	-	-	-	24		
28		82.5	82.5	82.5	82.5	82.5	82.5	76.3	66.4	-	-	-	-	-	-	-	28		
32		82.5	82.5	82.5	82.5	82.5	82.5	74.2	64.6	53.7	-	-	-	-	-	-	32		
36		-	76.2	76.6	76.3	75.7	73.8	69.2	61.2	52.1	42.2	-	-	-	-	-	36		
40		-	68.1	68.8	68.3	67.0	65.8	63.2	57.1	50.1	41.3	34.8	-	-	-	-	40		
48		-	-	50.8	52.4	51.9	50.6	48.6	46.2	43.5	38.9	34.2	28.6	23.6	-	-	48		
56		-	-	40.7	40.7	40.1	39.0	37.6	37.0	35.5	33.5	31.5	28.1	23.6	17.0	-	56		
64		-	-	24.0	32.6	31.9	30.8	31.4	30.1	29.0	28.1	27.5	25.8	23.4	17.0	-	64		
72		-	-	-	26.6	25.9	27.0	25.9	24.7	24.8	23.9	23.4	23.2	21.7	17.0	-	72		
80		-	-	-	-	22.9	22.6	21.5	21.9	20.7	20.4	20.6	19.2	18.5	16.5	-	80		
88		-	-	-	-	14.4	19.1	19.1	18.3	18.2	17.6	17.0	16.6	15.2	13.3	-	88		
96		-	-	-	-	-	16.1	16.5	16.1	15.3	14.8	14.5	13.9	12.4	10.7	-	96		
104		-	-	-	-	-	13.8	14.0	14.0	13.3	12.3	12.4	11.3	10.0	8.4	-	104		
112		-	-	-	-	-	-	10.5	11.8	11.1	10.9	10.3	9.4	8.1	6.5	-	112		
120		-	-	-	-	-	-	9.7	10.2	9.4	9.5	8.4	7.6	6.2	4.9	-	120		
128		-	-	-	-	-	-	-	8.7	7.9	7.9	6.9	6.1	4.7	3.5	-	128		
136		-	-	-	-	-	-	-	7.5	6.6	6.6	5.8	4.7	3.4	-	-	136		
144		-	-	-	-	-	-	-	-	3.4	5.6	4.7	3.6	2.3	-	-	144		
152		-	-	-	-	-	-	-	-	-	-	3.6	-	-	-	-	152		
160		-	-	-	-	-	-	-	-	-	-	2.8	-	-	-	-	160		
1)		39.0	29.1	22.9	18.1	14.6	11.5	9.0	6.8	4.9	3.7	-	-	-	-	-	1)		

1) Capacities with horizontal boom

☰ 13,900 lb		☰ 26.70 ft x 24.60 ft														360°		85%	
↙ ↘		(ft)														↙ ↘			
ft		40.7	54.1	67.6	81.0	94.5	107.9	121.4	134.8	148.3	161.4	174.9	188.6	202.1	223.1	ft			
		1,000 lb																	
10		82.5	82.5	82.5	-	-	-	-	-	-	-	-	-	-	-	-	10		
12		82.5	82.5	82.5	82.5	-	-	-	-	-	-	-	-	-	-	-	12		
14		82.5	82.5	82.5	82.5	-	-	-	-	-	-	-	-	-	-	-	14		
16		82.5	82.5	82.5	82.5	82.5	-	-	-	-	-	-	-	-	-	-	16		
18		82.5	82.5	82.5	82.5	82.5	-	-	-	-	-	-	-	-	-	-	18		
20		82.5	82.5	82.5	82.5	82.5	82.5	-	-	-	-	-	-	-	-	-	20		
24		82.5	82.5	82.5	81.3	79.4	78.8	73.1	-	-	-	-	-	-	-	-	24		
28		73.3	75.3	75.7	72.0	70.4	65.1	60.8	56.6	-	-	-	-	-	-	-	28		
32		55.4	59.0	60.3	61.6	57.8	53.8	51.2	47.9	43.7	-	-	-	-	-	-	32		
36		-	48.0	50.5	50.7	48.6	46.0	44.6	41.0	38.7	35.2	-	-	-	-	-	36		
40		-	39.1	40.7	40.9	40.5	41.0	38.1	36.9	35.0	33.1	30.9	-	-	-	-	40		
48		-	-	29.8	30.8	30.6	30.0	30.3	29.4	27.6	26.7	24.6	22.3	19.4	-	-	48		
56		-	-	22.6	23.4	23.3	23.5	23.4	22.6	21.5	20.7	18.9	16.8	14.5	12.2	-	56		
64		-	-	17.5	18.1	18.5	18.4	18.2	17.5	16.7	16.2	14.5	12.5	10.3	8.0	-	64		
72		-	-	-	14.2	14.6	14.4	14.2	13.5	12.7	12.4	10.9	8.9	6.9	4.9	-	72		
80		-	-	-	-	11.5	11.3	11.1	10.4	9.5	9.5	8.2	6.5	4.5	-	-	80		
88		-	-	-	-	9.2	9.0	8.8	8.1	7.2	7.2	6.0	4.2	-	-	-	88		
96		-	-	-	-	-	7.0	6.7	6.1	5.3	5.3	4.2	-	-	-	-	96		
104		-	-	-	-	-	5.5	5.0	4.4	3.7	3.7	2.8	-	-	-	-	104		
112		-	-	-	-	-	-	3.9	3.0	-	-	-	-	-	-	-	112		
1)		39.0	24.3	16.8	11.5	8.2	5.1	2.9	-	-	-	-	-	-	-	-	1)		

☰ 8,200 lb		☰ 26.70 ft x 24.60 ft														360°		85%	
↙ ↘		(ft)														↙ ↘			
ft		40.7	54.1	67.6	81.0	94.5	107.9	121.4	134.8	148.3	161.4	174.9	188.6	202.1	223.1	ft			
		1,000 lb																	
10		82.5	82.5	82.5	-	-	-	-	-	-	-	-	-	-	-	-	10		
12		82.5	82.5	82.5	82.5	-	-	-	-	-	-	-	-	-	-	-	12		
14		82.5	82.5	82.5	82.5	-	-	-	-	-	-	-	-	-	-	-	14		
16		82.5	82.5	82.5	82.5	82.5	-	-	-	-	-	-	-	-	-	-	16		
18		82.5	82.5	82.5	82.5	82.5	-	-	-	-	-	-	-	-	-	-	18		
20		82.5	82.5	82.5	82.5	82.3	82.1	-	-	-	-	-	-	-	-	-	20		
24		80.4	81.8	80.8	79.1	77.4	74.0	68.1	-	-	-	-	-	-	-	-	24		
28		66.8	70.7	69.9	67.9	64.1	59.2	55.1	51.9	-	-	-	-	-	-	-	28		
32		49.7	53.4	56.2	55.9	52.2	49.6	47.3	44.5	40.7	-	-	-	-	-	-	32		
36		-	44.0	45.7	45.9	43.7	43.4	39.9	38.6	35.8	33.4	-	-	-	-	-	36		
40		-	35.0	36.8	36.8	38.3	36.6	35.7	34.3	32.4	29.8	27.5	-	-	-	-	40		
48		-	-	27.0	27.9	27.5	27.9	27.6	25.9	24.3	23.5	21.5	19.3	16.8	-	-	48		
56		-	-	20.0	20.8	21.1	21.2	21.0	19.9	18.6	17.9	16.2	14.1	11.8	9.5	-	56		
64		-	-	15.0	15.9	16.5	16.3	15.9	15.2	14.3	13.6	12.0	10.0	7.8	5.6	-	64		
72		-	-	-	12.0	12.6	12.4	12.2	11.5	10.7	10.2	8.7	6.9	4.7	2.7	-	72		
80		-	-	-	-	9.8	9.5	9.3	8.7	7.8	7.6	6.3	4.5	-	-	-	80		
88		-	-	-	-	7.7	7.3	7.1	6.4	5.7	5.6	4.2	-	-	-	-	88		
96		-	-	-	-	-	5.6	5.3	4.7	3.8	3.9	-	-	-	-	-	96		
104		-	-	-	-	-	4.1	3.9	3.1	-	2.4	-	-	-	-	-	104		
1)		34.8	21.4	14.6	9.7	6.6	4.0	-	-	-	-	-	-	-	-	-	1)		

1) Capacities with horizontal boom

Ratings are in compliance with ASME B30.5.
Lifting capacities do not exceed 85 % of tipping load.

Consult operation manual for further details.

Note: Data published herein is intended as a guide only and shall not be construed to warrant applicability for lifting purposes. Crane operation is subject to the computer charts and operation manual both supplied with the crane.

Basic machine

Equipment carrier

Engine 405-4	Scania DC13; Diesel engine; 405 kW / 2100 1/min (550 HP), torque 2476 Nm / 1400 1/min; The engine complies with Tier 4F; Exhaust system complete stainless steel.
Fuel tank	Fuel tank 127 gallons Diesel (no RME / biodiesel); 16 gallons AdBlue tank.
Transmission ZF TraXon	ZF TraXon; Automated gearbox with integrated hydraulic retarder, 12 forward speeds and 2 reverse; 2-stage transfer case with switchable longitudinal lock.
Axles 10 x 6 x 10	10 x 6 x 10; Five axles, axles 2, 4, 5 are driven and dispose of a selectable transverse lock; Axle 4 with selectable longitudinal lock; All axles steered.
Suspension	Hydropneumatic suspension with axle load compensation; Hydraulically lockable.
Steering	Dual-circuit steering system with independent rear axle steering; Axles 1, 2, 3 mechanically connected; Axles 4 and 5 electro-hydraulically connected, all axles steered with 6 different steering programs.
Brakes	Pneumatic dual circuit service brake, acting on all wheels; Disc brakes; Hydraulic retarder integrated into transmission as wear-free sustained-action brake; Additional exhaust brake; Parking brake.
Tires size 385/95 R25 (14.00R25)	Tires size 385/95 R25 (14.00R25); Steel rim 9,5-25/1,7"; TechKing ETCRANE 170F or similar.
Cab 2550	Type 8.4 ft; Adjustable driver seat, armrests and pneumatic suspension; Height and tilt-adjustable steering wheel; Auxiliary / passenger seat; Powered door windows; Tinted glass; Central door locking; Electrically adjustable rear-view mirrors, heated; Radio; Seat heating.
Heating engine-dependent	Engine-dependent warm water heating with 12 kW heating power.
Aircondition	Aircondition for carrier cab, 7 kW rated cooling power.
Drive lights	Including low beam, upper beam, daytime running lights, fog lights and cornering lights.
Outriggers	H-4-point design; Vertical and horizontal movement fully hydraulic; Manual or automatic levelling alternatively; 3 outrigger bases: 8.3 ft, 17.4 ft, 24.6 ft.
Outrigger pads 038PA	4 round polyamide outrigger pads A = 0,38 m ² with transport position at vertical cylinder.
Outrigger basis monitoring	Individual monitoring of horizontal stroke; Deviation warning in crane cab.
Outrigger load indicator	The outrigger load is indicated in the operator cab and the outrigger control box.
Electronic immobilizer system	Prevents uncontrolled carrier mobilization; Incl. 5 ignition keys.
Pneumatic system adapter for inflating tires	Pneumatic system adapter for inflating tires makes it possible for operators to inflate tires by themselves.
Contour safety marking	Continuous reflective strips on the sides of the chassis and on the rear.

Equipment superstructure

Telescopic boom HA68	40.7 ft - 223.1 ft; Single cylinder telescoping system, automatic telescoping; Attachments for all equipment and extensions; 4 sheaves integrated in boom head for max. capacity of 168,900 lb.
Boom luffing	1 luffing cylinder with automatic lowering brake valve.
Rotary drive	Single slewing gear unit with spring-loaded multi-disc brake; Different operating modes selectable.
H1	Hoist with spring-loaded multi-disc brake; Resolver (hoist rotation indicator); Incl. hoist monitoring.
Counterweight 71,900 lb	Counterweight 71,900 lb, 6 pieces (a-f); Automatic rigging system.
Control system	Enabling 4 simultaneous working movements; Electric pilot controls via 2 two-axis joysticks; Different control modes selectable for hydraulic circuits.
Operator aids	IC-1, with integrated electronic load moment indicator in accordance with EN13000; Color display; Displaying of current operating conditions, load charts, fault indicator; Signal lights indicating LMI-load; Crane data logger.
Working range limiter	Displaying and programmability of the work range limits by IC-1.
Hook height indication	Displaying and programmability of the hook height H1 by IC-1.
Cab 875	Type 2.87 ft; Tilt infinitely variable 16°; Sliding window rear; Fold-out front window; Extendable side pedestal, front pedestal; Handrails; Tinted safety glass; Pull-down sun visor; Radio; Seat heating.
Heating engine-independent	Engine-independent warm water heating with 5 kW heating power.
Aircondition	Aircondition in crane cab with 5 kW rated cooling power.
Anemometer	Removable, to be used with all extensions.

Additional equipment

Carrier

Engine 331-3	Scania DC13; Diesel engine; 331 kW / 2100 1/min (450 HP), torque 2007 Nm / 1575 1/min; The engine complies with EU Stage III A / Tier 3; Exhaust system optional with spark arrester.
Axles 10 x 8 x 10	10 x 8 x 10; Five axles, axles 1, 2, 4, 5 are driven and dispose of a selectable transverse lock; Axles 2 and 4 with selectable longitudinal lock; All axles steered.
Additional fuel tank	Additional fuel tank 37 gallons; For 164 gallons diesel total in carrier (no RME / biodiesel).

Superstructure

Heavy lift attachment	2 additional sheaves; Dis-/connectable; For total 6 sheaves at boom head; Max. capacity 244,800 lb.
2. hoist (H2)	2. hoist; Spring-loaded multi-disc brake; Integrated resolver (hoist rotation indicator); Incl. quick couplings and transport rack.
Additional counterweight 29,600 lb	Additional counterweight 29,600 lb; 2 pieces; for total 101,400 lb, 8 pieces.
Load supervision camera	Camera mounted on main boom head to supervise the hook block and load from above; Incl. boom head light on boom head.

Handling

Remote control	Control of superstructure movements via wireless remote control.
IC-1 Plus	Smart crane control system for main boom operation enabling higher lifting capacities especially over outriggers. Enables safe use of the full capacity of the crane even in asymmetric outrigger configurations. Outriggers can be positioned independently. Capacity precalculation for +/- 30° slewing angle and radius area. In-cab lift simulation.
IC-1 Remote	IC-1 Remote, Demag telematic system.

Extensions

HAV 36.1 ft	37.4 ft; Lattice swing-away jib, manually offsettable 20°/40°; 1-sheaved head; Incl. transport storage.
HAV 68.9 ft	68.9 ft; Double folding swing-away jib, manually offsettable 20°/40°; 1-sheaved head; Incl. transport storage; Includes HAV 36.1 ft.
HAV-VA 108.3 ft	108.3 ft; Variable extension; Single piece, 39.4 ft lattice boom extension and double folding swing-away jib, manually offsettable 20°/40°; 1-sheaved head; Incl. transport storage for double folding swing-away jib; Includes HAV 36.1 ft, HAV 68.9 ft and HAV-VA 75.5 ft.
HAV-HY	Hydraulic offset 0°-40° instead of manual offset 20°/40°; available for HAV 36.1 ft, HAV 68.9 ft, HAV-VA 108.3 ft.
MS (runner)	5.25 ft; Fixed angle runner; 2 sheaves, for max. 86,200 lb lifting capacity; Incl. transport storage at the left side of main boom; Not transportable within 9 ft crane width.

Hook Blocks

Hook block 160-7-21-D-1500	160-7-21-D (3310 lb); Hook block with ramshorn hook; white with red signal stripes.
Hook block 125-5-21-D-1125	125-5-21-D (2480 lb); Hook block with ramshorn hook; white with red signal stripes.
Hook block 80-3-21-D-850	80-3-21-D (1870 lb); Hook block with ramshorn hook; white with red signal stripes.
Hook block 32-1-21-D-600	32-1-21-D (1320 lb); Hook block with ramshorn hook; white with red signal stripes.
Hook 12-0V-E-350	12-0V-E (770 lb); Single hook with vertical swivel; red.

Further additional equipment on request!

Weight data may deviate from posted values based on road / travel configuration, equipment configuration, and component weight tolerances.

January 2020. Product specifications and prices are subject to change without notice or obligation. The photographs and/or drawings in this document are for illustrative purposes only. Refer to the appropriate Operator's Manual for instructions on the proper use of this equipment. Failure to follow the corresponding Operator's Manual when using our equipment or to otherwise act responsibly may result in serious injury or death. The only warranty applicable to our equipment is the standard written warranty applicable to the particular product and sale and Demag makes no other warranty, express or implied. All rights reserved. Products and services listed may be trademarks, service marks or trade-names of Demag IP Holdings GmbH.

© Tadano Demag GmbH 2020. Demag is a trademark of Tadano Demag GmbH.



Tadano Demag GmbH
Europa Allee 2
66482 Zweibrücken
Germany
T +49 6332 830

www.demagmobilecranes.com



Tadano Ltd. (International Division)
4-12, Kamezawa 2-chome
Sumida-ku Tokyo 130-0014, Japan
E info@tadano.com T 81-3-3621-7750
www.tadano.com